



2024 DEALER WORKBOOK

CONTENTS

- 2 Technology
- 4 SBE 3 BE.S.T.
- 12 SBE 3 – 12-ga., 3.5"
- 14 **NEW** SBE 3 – 3" Models Intro.
- 18 **NEW** SBE 3 – 20-ga. Models
- 20 **NEW** SBE 3 – 28-ga. Models
- 22 ETHOS
- 24 ETHOS Cordoba BE.S.T.
- 26 ETHOS SuperSport
- 28 ETHOS Sport
- 30 M2 Field
- 32 Montefeltro
- 34 **NEW** Monte Sporting
- 34 **NEW** Monte Ultra Light
- 36 Montefeltro Silver
- 36 Montefeltro Silver FW
- 39 Defense Guns – M4
- 40 Defense Guns – M2, M3
- 42 SuperNova
- 43 Nova
- 44 828U
- 48 828U Sport
- 50 **NEW** 828U Steel Field
- 50 **NEW** Performance Shop
- 52 **NEW** Advanced Impact
- 60 Turkey Guns
- 62 LUPO Rifles
- 70 **NEW** LUPO HPR
- 74 **NEW** R1 Endurance
- 76 Accessories
- 79 **NEW** Gear
- 92 Price List



PERFORMANCE SHOP
SBE 3 WATERFOWL EDITION
20-GAUGE (See page 58)



BE.S.T.

BENELLI SURFACE TREATMENT

Harsh environments wreak havoc on gun metal. Benelli spent more than a decade developing BE.S.T. (Benelli Surface Treatment), a proprietary coating that protects steel with a tough, impenetrable armor that stops rust and corrosion. Applied using nanotechnology and diamond-like carbon particles, BE.S.T. outperforms every other available coating and surface treatment in the firearms market today. Parts treated with BE.S.T. have been tested by immersing them in saltwater for months with no signs of rust or corrosion.

Benelli BE.S.T. surface treatment is simply the most effective rust and corrosion firearm protection available. Benelli is so confident in the BE.S.T. performance that treated parts are backed with a 25-year warranty against rust and corrosion. Available in 2024 on select SBE 3, ETHOS and Lupo models. See pages 4-5, 24-25, 54-55, 58-59, 64-66 and 70-71 for additional details.

In addition to Benelli's industry-leading 10-year warranty, BE.S.T.-treated barrels and parts carry a warranty against rust and corrosion for 25 years from the date of purchase.

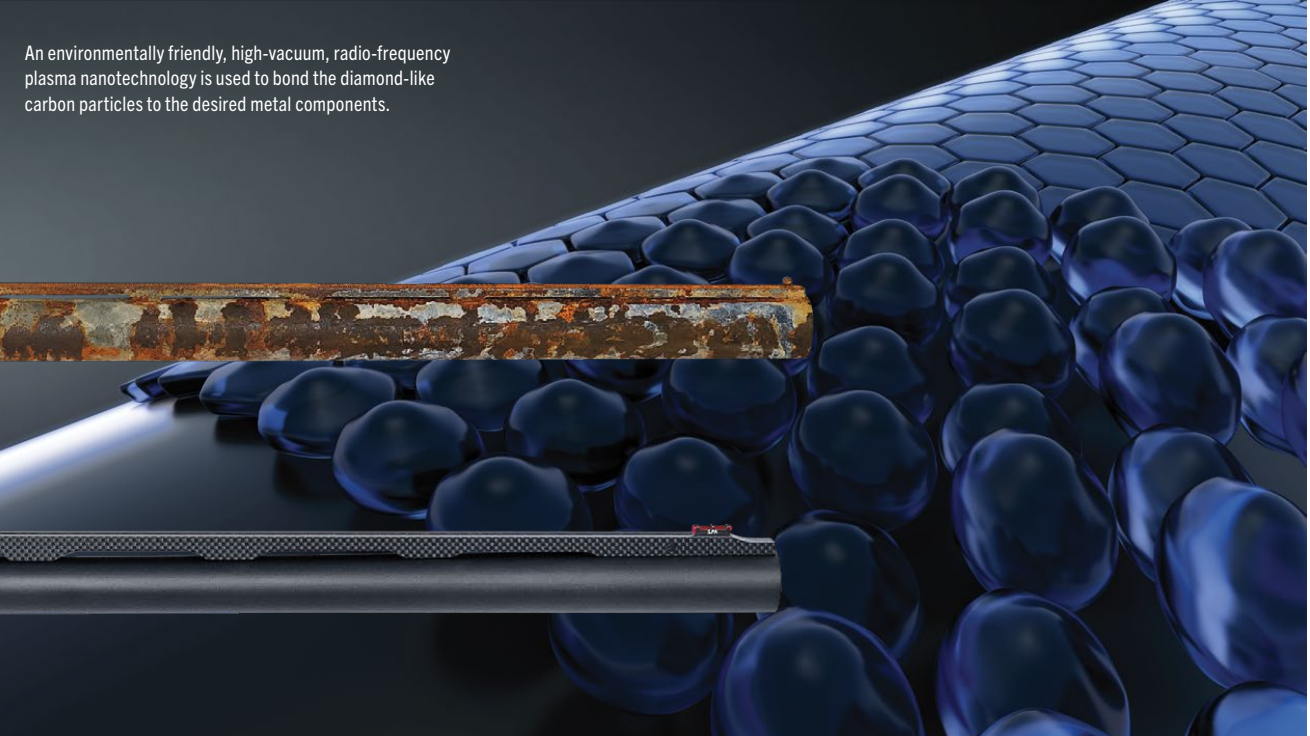

An environmentally friendly, high-vacuum, radio-frequency plasma nanotechnology is used to bond the diamond-like carbon particles to the desired metal components.



A competitor's barrel showing the damage from 48 hours of saltwater exposure.



A Benelli BE.S.T.-treated barrel with no sign of rust or corrosion after 3 months of saltwater exposure.

BE.S.T.

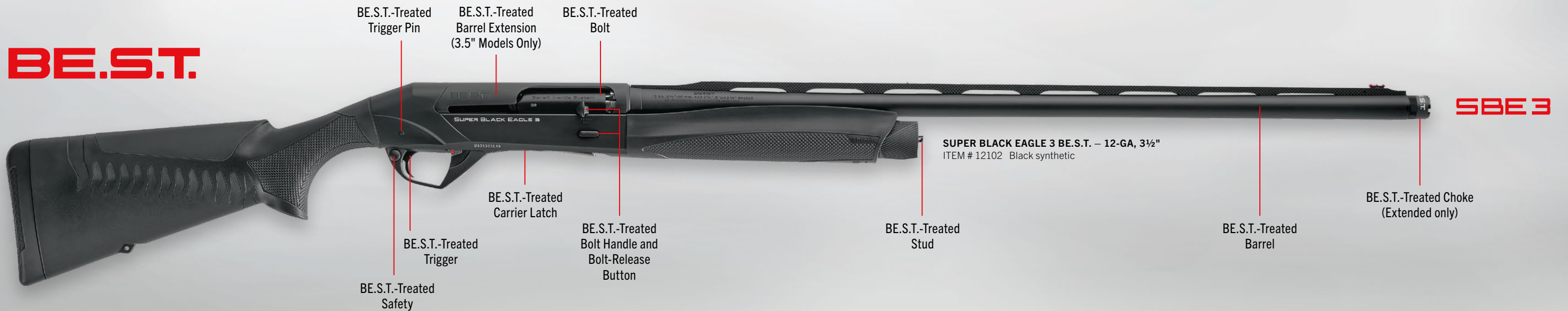

The development of BE.S.T. technology

BE.S.T. (Benelli Surface Treatment) is a new proprietary finishing technology developed by engineers and scientists at Benelli's manufacturing headquarters in Urbino Italy. It is a hybrid Physical Vapor Deposition (PVD) and Plasma Enhanced Chemical Vapor Deposition (PECVD) technology that applies a protective coating to parts.

This coating provides corrosion and abrasion resistance that is superior to any other firearm finish on the market. PVD and PECVD processes utilize electricity, radio frequencies, and plasma in a high-vacuum environment to deposit a solid coating that precisely and uniformly covers the treated parts. Diamond-like carbon particles are applied using nanotechnology, resulting in an exceptionally hard surface that is difficult to scratch, and won't ever rust or corrode.

The graphitic components of the coating layer also greatly reduce the amount of oil and maintenance required. While these technologies have been used in many industries for some time, applying them to a shotgun barrels had never been practical until Benelli's breakthrough. Typical deposition processes operate at high temperatures. Treating a shotgun barrel in such an environment would ruin the ballistic properties of the barrel and weaken the strength of the barrel extension. Benelli's engineers created a process that completes the process at low temperature, maintaining the perfect ballistics of our Crio-treated barrels and the heat-treated strength of the barrel extension.

Benelli developed this chemical makeup and made modifications to machinery to apply the new BE.S.T. coating at low temperatures in order to make it usable on shotguns. As an added bonus, Benelli's new process produces no emissions or waste, poses no health or safety risks to operators, and is environmentally friendly.

SUPER BLACK EAGLE 3 — BE.S.T.					
ITEM NUMBER	BARREL LENGTH	STOCK	OVERALL LENGTH	AVERAGE WEIGHT	MSRP
SUPER BLACK EAGLE 3 BE.S.T. — 28-GAUGE 2¾" AND 3"					
12105	26"	Black synthetic	47.5"	5.5 lbs.	\$2299
12106	28"	Black synthetic	49.5"	5.6 lbs.	\$2299

COMMON SPECIFICATIONS: Magazine Capacity: 2+1 Crio® Flush Chokes: C,IM,F Crio® Extended Chokes: IC,M Type of Sights: Red-bar front sight Length of Pull: 14¼" Drop at Heel: 2¼" Drop at Comb: 1¼" Minimum recommended load: ¾-oz. loads (28-ga.)

SUPER BLACK EAGLE 3 — BE.S.T.					
ITEM NUMBER	BARREL LENGTH	STOCK	OVERALL LENGTH	AVERAGE WEIGHT	MSRP
SUPER BLACK EAGLE 3 BE.S.T. 12-GAUGE 2¾", 3" AND 3½" †					
12101	26"	Black synthetic	48"	6.9 lbs.	\$2499
12102	28"	Black synthetic	50"	7.0 lbs.	\$2499

COMMON SPECIFICATIONS: Magazine Capacity: 3+1 Crio® Flush Chokes: C,IM,F Crio® Extended Chokes: IC,M Type of Sights: Red-bar front sight Length of Pull: 14¼" Drop at Heel: 2¼" Drop at Comb: 1¼" Minimum recommended load: 3-dram, 1¼-oz. loads (12-ga.) †Receiver drilled and tapped for 93A Weaver base.

SUPER BLACK EAGLE 3 — BE.S.T.					
ITEM NUMBER	BARREL LENGTH	STOCK	OVERALL LENGTH	AVERAGE WEIGHT	MSRP
SUPER BLACK EAGLE 3 BE.S.T. — 20-GAUGE 2¾" AND 3"					
12103	26"	Black synthetic	47.5"	5.8 lbs.	\$2299
12104	28"	Black synthetic	49.5"	5.9 lbs.	\$2299

COMMON SPECIFICATIONS: Magazine Capacity: 3+1 Crio® Flush Chokes: C,IM,F Crio® Extended Chokes: IC,M Type of Sights: Red-bar front sight Length of Pull: 14¼" Drop at Heel: 2¼" Drop at Comb: 1¼" Minimum recommended load: 2¼-dram, 7⁄8-oz. loads (20-ga.)



Benelli's Inertia Driven® System.

"THE LAW OF INERTIA"— is Newton's First Law of Physics and is as consistent and unchangeable as The Law of Gravity. Benelli has harnessed this basic law of physics in the Inertia Driven® System to operate the world's fastest, simplest and most reliable semi-automatic shotguns. It's not boasting, it's the law — The Law of Inertia.

RELIABLE — The Inertia Driven® System never needs adjusting and will cycle anything from light field loads to 3½" magnums with consistent reliability year after year. In fact, there are Inertia Driven® Benelli shotguns that have fired more than 500,000 rounds, still in the field and functioning perfectly.

SIMPLE — Inertia Driven® is simple with only three primary parts: the bolt body, the inertia spring and the rotating bolt head. Simple is better.

FASTER — By greatly reducing the mass of the system's parts, we made Inertia Driven® faster.

CLEANER — Gas, smoke and burned powder are not channeled into the gun's firing mechanism, as they are in gas systems, allowing more efficient operation and easier firearm cleaning.

STRONG — The strong steel locking lugs on the Inertia Driven® System's rotating bolt head not only lock steel-to-steel into the gun's barrel; the lugs lock-in even tighter during firing.

LOW MAINTENANCE — Because the Inertia Driven® System functions so much cleaner than conventional gas-operated semi-automatics, gun cleaning takes a fraction of the time. You spend more time shooting and less time cleaning.

LIGHT WEIGHT — The Inertia Driven® System is not only simple, it's also lightweight. Benelli shotguns are among the lightest semi-automatic shotguns ever produced. This allows for faster shouldering, quick target acquisition, easy-swinging follow through and less fatigue during long days in the field.

PERFECT BALANCE — With no springs, action bar linkage or heavy gas cylinder under the forend, Benelli's Inertia Driven® shotguns balance like fine game guns should.

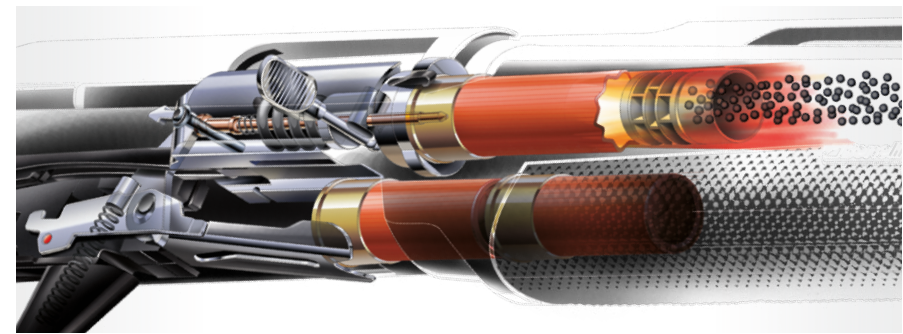

Benelli's Crio System technology.

Cryogenic physics has revealed steel changes at the molecular level when cooled to -300° F. When a Benelli barrel is cryogenically treated, all the stresses caused by hammer forging are relieved and the surface of the bore becomes more even-grained. The result is a slicker surface offering less resistance to wads and shot charges. With smoother, more uniform surfaces, Benelli Crio® barrels deliver superior patterns and stay clean longer.

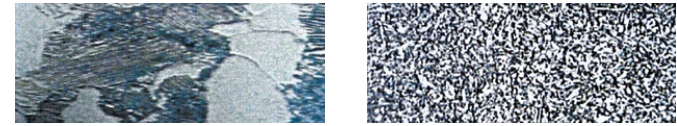

UNTREATED STEEL

CRYOGENICALLY TREATED STEEL

Crio® Chokes are the second part of the Benelli Crio® System. Extra-long choke tubes with more gradual constriction, coupled with the slick surface created by cryogenic treatment, put more pellets on target and yield denser, more uniform shot patterns.

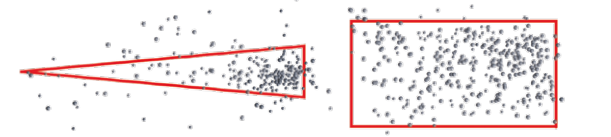

UNTREATED
Irregular and uneven shot pattern.

CRYOGENICALLY TREATED
Denser and more uniform shot pattern.



The Crio® System combines a barrel frozen to -300° F with a specially designed longer choke tube that is also cryogenically treated. The result is a denser, more uniform shot pattern that puts more pellets on target.

Benelli's unrivaled recoil-reduction systems.

Benelli has developed the performance of recoil-reducing technology to a level that leaves the competition behind. Three recoil-reduction systems have been optimized specifically for the platforms they serve, delivering unrivaled results in reducing felt recoil.



AVAILABLE MODELS:
ETHOS LUPO HPR
828U SBE 3 Wood
LUPO

The Progressive Comfort recoil-reduction system is an unobtrusive, lightweight and simple system. It's able to self-adjust for maximum recoil reduction related to the power of the load used because it has three sets of interlocking leaves, or fingers, with different levels of elasticity. This system is out of sight inside a wooden stock to better maintain a traditional look.



Progressive Comfort



AVAILABLE MODELS:
Super Black Eagle 3
ETHOS Cordoba BE.S.T.
ETHOS SuperSport
R1 Endurance

ComforTech™ was the first recoil-reduction system of its kind. By splitting the stock diagonally and utilizing shock-absorbing chevrons, the entire stock was transformed into a recoil pad. This chevron system, now 16 years old, is still the most efficient design available and was the basis for the SBE 3 stock. The chevron size and location has been optimized on ComforTech 3. Further, Benelli engineers created a new cheek-comb pad called Combtech, which greatly reduces facial impact and vibrations.

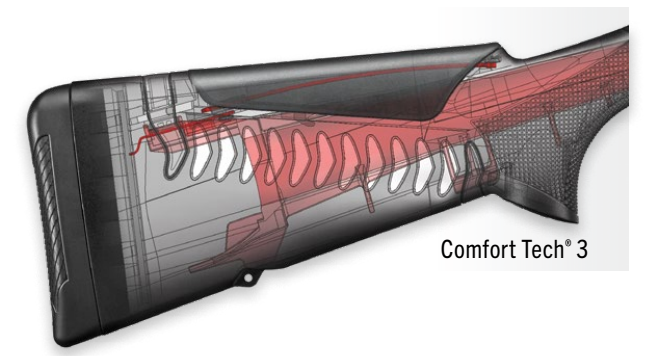

ComforTech® 3



AVAILABLE MODELS:
Super Nova
M2 Tactical

Benelli's ComforTech™ system revolutionized shooting comfort by reducing felt recoil without adding weight. Originally designed for the SBE II platform, its success and popularity compelled us to offer it in other Benelli models.



ComforTech®



Benelli's unmatched 10-year warranty. Our industry-leading 10-Year Warranty (U.S. only), guarantees if anything should go wrong under normal use, your firearm will be serviced by skilled gunsmiths at our national firearm service center. While your Benelli is under warranty, we will assume the cost of parts, labor and shipping required to get your firearm back to you and working perfectly.

SUPER BLACK EAGLE 3



ComforTech 3 System Provides Greater Recoil Reduction



Dominate the skies with the Super Black Eagle 3

SBE 3—The full redesign of our venerable Super Black Eagle platform. With carefully considered insights from our pro-staff and veteran hunters, Benelli design engineers have spent nearly 10 years in development focused on areas of critical importance to serious hunters. These included improved ergonomics; intuitive, flawless functionality; updated design, style and feel for the latest in modern hunting reliability that's all about the endgame, and absolute superiority in the most unforgiving conditions.

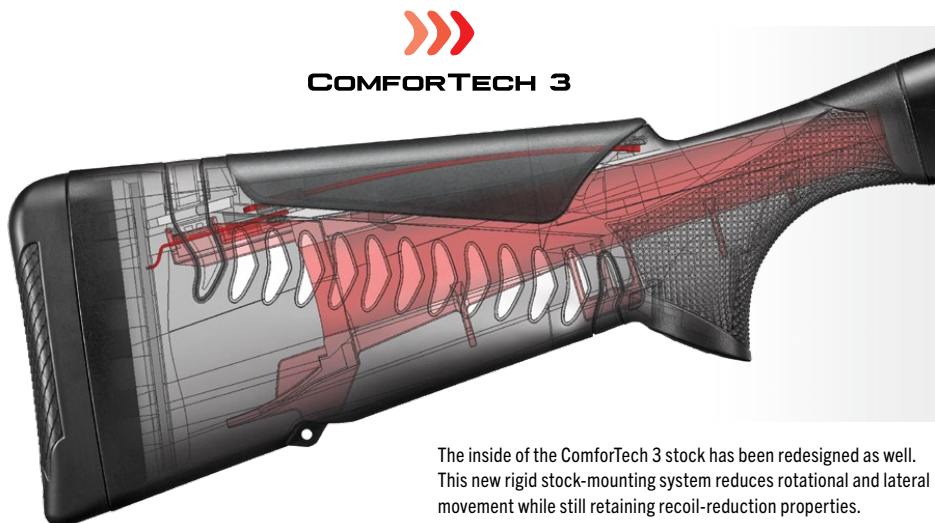

The inside of the ComforTech 3 stock has been redesigned as well. This new rigid stock-mounting system reduces rotational and lateral movement while still retaining recoil-reduction properties.

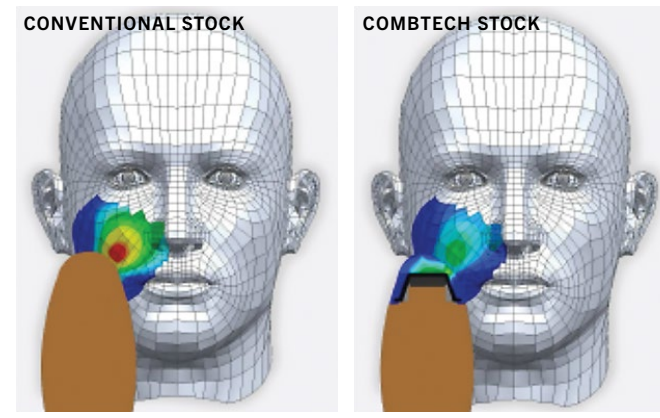

When considering total recoil, vibrations and impact to the face are often overlooked. Benelli realized that improvements could be made to the stock comb to reduce facial impact and developed the Combtech system. Combtech is simple but highly effective in reducing force transferred to the cheek area, resulting in a softer-shooting gun that allows you to shoot better.



The removable, extra-soft Combtech recoil pads require no tools, making field adjustments or replacements fast in even the coldest, wettest conditions. Optional pads of varying height are available if needed.

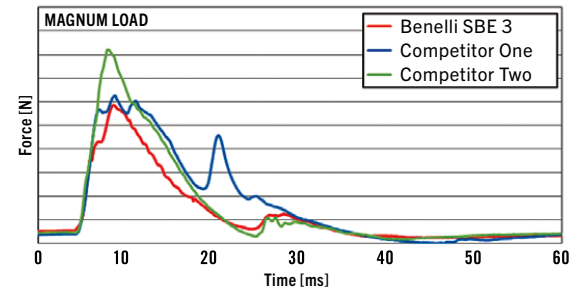
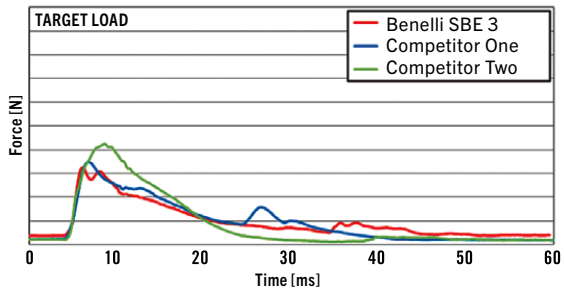

ComforTech 3 advancements focus on recoil reduction in both the shoulder and, equally important, the face (as seen in the facial recoil-mapping illustrations on page 9).



Enhanced comfort and less recoil drastically reduce flinching on the first shot, resulting in faster follow-up shots, more pellets on target and more birds down.



The Combtech pad is easily removed from the ComforTech 3 stock by simply pulling the release tab upward and toward the rear of the buttstock.

SUPER BLACK EAGLE 3

Inertia Driven System

The hallmark of Benelli strength and reliability, our clean-burning Inertia Driven System never requires adjusting, cycles consistently in conditions that border on unfair, and easily handles everything from light field loads to 3½" magnums.

From a cleanliness and speed perspective, gas systems simply cannot compete—whereas Inertia-Driven Benelli shotguns are known to fire 500,000+ rounds and still function flawlessly.

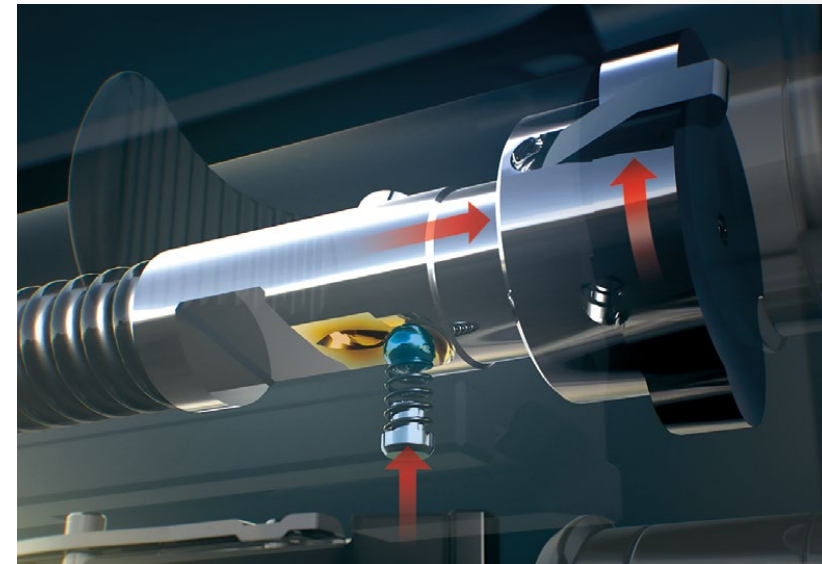

Easy-Locking Bolt System

Versatility without compromise: having a shotgun with a 3½" chamber does not mean you must always shoot the powerful stuff. The SBE 3's patented locking mechanism works flawlessly with all shotgun loads—from light clay loads to the ultimate goose-busters.

◀ A spring-activated ball detent slides effortlessly in the bolt, locking it into battery no matter the pressure. Also, if the bolt is accidentally bumped or pulled back even by a small amount, the detent's pressure will guide it back into the locked position. Result: the SBE 3 will always be ready to fire when you are and with whatever shotshells you choose.



Quicker and Easier Operation

A larger bolt release and safety along with an outward angled drop lever make the SBE 3 quicker and easier to operate—even with gloved hands.

Easy-Loading System

A beveled loading port, redesigned carrier and a new two-piece carrier latch have all been incorporated into the new Super Black Eagle 3 to make loading the magazine effortless.

During loading, only the front section of the Easy-Loading System's two-piece carrier latch actually moves, allowing shells to slide up easily with minimal tension or possibility of jamming. ▶

Grooves in the loading port help you guide shells in without having to take your eyes off incoming birds. The new, beveled loading port also features a wider design to help funnel shells toward the magazine, a must for gloved hunters. ▶

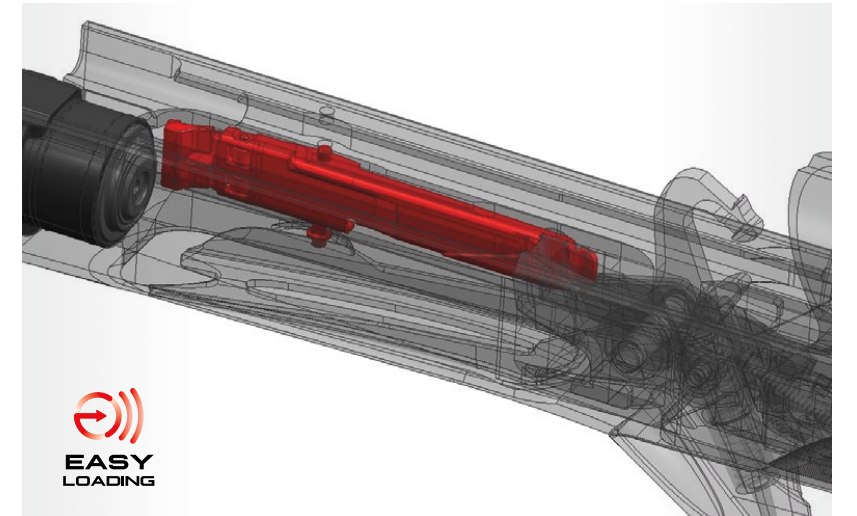

Super Black Eagle 3 Dominate the Skies



SUPER BLACK EAGLE 3 BE.S.T. – 12-GA, 3½"
ITEM # 12102 Black synthetic



Launched in 1991, the Super Black Eagle quickly reset reliability expectations for semi-automatic shotguns. Today, with the third generation of the SBE, this legendary reliability has been carried forward by combining modern technology with improved ergonomics.



BE.S.T.

An upsized bolt handle teams with an enlarged bolt release and oversized safety to make operation easier with cold or gloved hands.



Our redesigned triangular mag cap has more pronounced edges, allowing for excellent grip and leverage when tightening or loosening in wet, cold conditions.



SUPER BLACK EAGLE 3 – 12-GA, 3½"
ITEM # 10311 Realtree® Max-7™



SUPER BLACK EAGLE 3 – 12-GA, 3½"
ITEM # 10351 Mossy Oak® Bottomland™



SUPER BLACK EAGLE 3 — STEADYGRIP™ – 12-GA, 3½"
ITEM # 10352 Mossy Oak® Bottomland™



SUPER BLACK EAGLE 3 – 12-GA, 3½"
ITEM # 10361 GORE™ OPTIFADE™ Waterfowl Timber



SUPER BLACK EAGLE 3 – 12-GA, 3½"
ITEM # 11230 GORE™ OPTIFADE™ Waterfowl Timber, Tungsten Cerakote

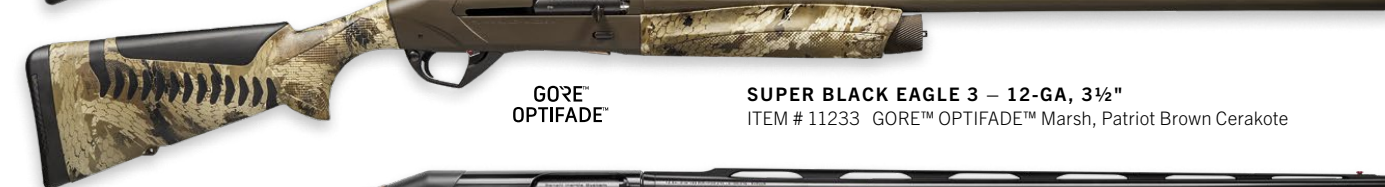

SUPER BLACK EAGLE 3 – 12-GA, 3½"
ITEM # 11233 GORE™ OPTIFADE™ Marsh, Patriot Brown Cerakote

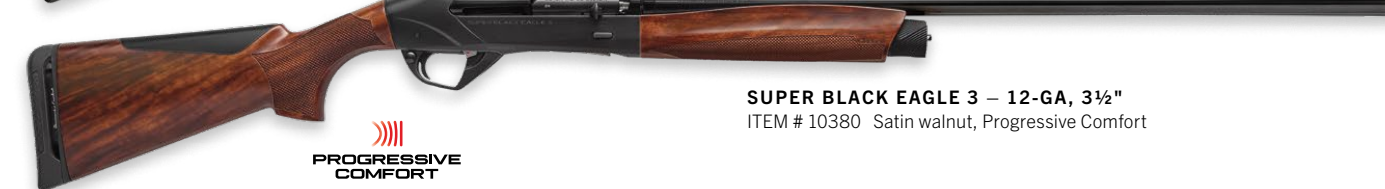

SUPER BLACK EAGLE 3 – 12-GA, 3½"
ITEM # 10380 Satin walnut, Progressive Comfort

STANDARD FEATURES

- EXTENDED CHOKE TUBES:** IC, M, Crio® chokes.
- FLUSH CHOKE TUBES:** C, IM, F Crio® chokes and wrench.
- FINISHES:** BE.S.T. Treatment, Realtree® Max-7, Black synthetic, Mossy Oak® Bottomland,™ GORE™ OPTIFADE™ Timber, GORE™ OPTIFADE™ Marsh, GORE™ OPTIFADE™ Timber/Tungsten Cerakote, Satin walnut, GORE™ OPTIFADE™ Marsh/Patriot Brown Cerakote.
- BARRELS:** Crio®-treated barrel.
- RECOIL PADS:** Comfort Tech® 3 recoil pads and Combtech pads.
- SHIM KIT:** For adjustment of drop and cast.
- HARD CASE:** Custom fitted hard case to protect during transport (not included with SteadyGrip™ model).

OPTIONAL FEATURES

- CHOKE TUBES:** Extended Crio® chokes C, IM, F and XF for turkey.
- COMFORTTECH 3 RECOIL PADS:** Three options to customize length of pull to 13⁷/₈", 14³/₈" or 14³/₄".
- COMB-TECH® RAISED COMB PADS:** Two options to customize sight plane for different shooting scenarios.

SUPER BLACK EAGLE 3					
ITEM NUMBER	BARREL LENGTH	STOCK	OVERALL LENGTH	AVERAGE WEIGHT	MSRP
SUPER BLACK EAGLE 3 BE.S.T. 12-GAUGE 2¾", 3" AND 3½" †					
12101	26"	Black synthetic	48"	6.9 lbs.	\$2499
12102	28"	Black synthetic	50"	7.0 lbs.	\$2499
SUPER BLACK EAGLE 3 12-GAUGE 2¾", 3" AND 3½" †					
10321	26"	Black synthetic	48"	6.9 lbs.	\$2199
10316	28"	Black synthetic	50"	7.0 lbs.	\$2199
10380	28"	Satin walnut	50"	7.0 lbs.	\$2199
10310	26"	Realtree® Max-7™	48"	6.9 lbs.	\$2299
10311	28"	Realtree® Max-7™	50"	7.0 lbs.	\$2299
10360	26"	GORE™ OPTIFADE™ Timber	48"	6.9 lbs.	\$2299
10361	28"	GORE™ OPTIFADE™ Timber	50"	7.0 lbs.	\$2299
10385	28"	GORE™ OPTIFADE™ Marsh	50"	7.0 lbs.	\$2299
10350	26"	Mossy Oak® Bottomland™	48"	6.9 lbs.	\$2299
10351	28"	Mossy Oak® Bottomland™	50"	7.0 lbs.	\$2299
10352	24"	Bottomland™ SteadyGrip™	46"	6.8 lbs.	\$2349
11230	28"	Timber/Tungsten	50"	7.0 lbs.	\$2399
11233	28"	Marsh/Patriot Brown	50"	7.0 lbs.	\$2399

COMMON SPECIFICATIONS: Magazine Capacity: 3+1 Crio® Flush Chokes: C,IM,F Crio® Extended Chokes: IC,M Type of Sights: Red-bar front sight Length of Pull: 14¼" Drop at Heel: 2¼" Drop at Comb: 1¼" Minimum recommended load: 3-dram, 1¼-oz. loads (12-ga.) †Receiver drilled and tapped for 93A Weaver base.

Super Black Eagle 3 Left-Hand



SUPER BLACK EAGLE 3 – 12-GA, 3½"
ITEM # 10376 Realtree® Max-7™



SUPER BLACK EAGLE 3 – LEFT-HAND

ITEM NUMBER	BARREL LENGTH	STOCK	OVERALL LENGTH	AVERAGE WEIGHT	MSRP
SUPER BLACK EAGLE 3 12-GAUGE 2¾", 3" AND 3½" †					
10371	28"	Black synthetic	50"	7.0 lbs.	\$2199
10376	28"	Realtree® Max-7™	50"	7.0 lbs.	\$2299

COMMON SPECIFICATIONS: Magazine Capacity: 3+1 Crio® Flush Chokes: C,IM,F Crio® Extended Chokes: IC,M Type of Sights: Red-bar front sight Length of Pull: 14¼" Drop at Heel: 2¼" Drop at Comb: 1¼" Minimum recommended load: 3-dram, 1¼-oz. loads (12-ga.) †Receiver drilled and tapped for 93A Weaver base.

All the revolutionary features that have made the Super Black Eagle 3 America's favorite 3½"-shell-shooting shotgun are now available for southpaws. And no, this is not a shortcut-filled "adaptation." It is a perfect left-handed mirror image of the original Super Black Eagle 3—in either a Realtree® Max-7™ camo pattern or in black synthetic.

SPECIFICATIONS AND PRICES
SUBJECT TO CHANGE WITHOUT NOTICE.

Super Black Eagle 3

Dominating the Skies
for Three Decades



SBE 3
28 - GAUGE
3" CHAMBER

SBE 3
20 - GAUGE
3" CHAMBER



The Benelli Super Black Eagle semi-automatic shotgun sets the standard of excellence for hunting firearms. It's been dominating the skies for decades as Benelli's innovative engineers continued to refine the original SBE design by adding new performance-enhancing technologies such as recoil-reducing ComforTech® 3, shock-absorbing Combttech, Perfect Fit drop and cast adjustment, and the ultra reliable Inertia Driven® system. Add to those more subtle improvements such as a carbon-fiber stepped rib, easy-locking bolt system, an enlarged bolt handle and bolt release, a fiber-optic front sight, extended Crio choke tubes, sling attachment points and more, and you've got SBE3 shotguns ready to dominate the skies for years to come.

Benelli offers the SBE3 in 12-gauge, 20-gauge, and now a new 28-gauge model, all chambered to accept shells up to 3". Enjoy all the features, attributes and excellence of the SBE3 3.5" models in versions that are a little lighter but just as effective and enjoyable to shoot.



- ▲
SBE 3
28-Ga., 3"
26" barrel -
5.5 lbs.
- ▲
SBE 3
20-Ga., 3"
26" barrel -
5.8 lbs.
- ▲
SBE 3
12-Ga., 3"
26" barrel -
6.8 lbs.
- ▲
SBE 3
12-Ga., 3.5"
26" barrel -
6.9 lbs.



SBE3

12 - GAUGE
3" CHAMBER



SUPER BLACK EAGLE 3 – 12-GA, 3"
ITEM # 10353 Mossy Oak® Bottomland™



Launched in 1991, the Super Black Eagle quickly established dominance of both the skies and the hunting shotgun market. Today, the third generation of the SBE platform carries forward Benelli's reputation for reliability and innovation in the SBE3. Optimized for hunting by integrating the latest ergonomic science, recoil-reducing technology and hunt-enhancing performance features, the SBE3 is now available in a 12-gauge model chambered for 3" shells. You get the legendary all-weather performance and rugged reliability of the SBE3, 3.5"-inch models in a shotgun made to shoot both 3" and 2-3/4" shells.



SUPER BLACK EAGLE 3

ITEM NUMBER	BARREL LENGTH	STOCK	OVERALL LENGTH	AVERAGE WEIGHT	MSRP
SUPER BLACK EAGLE 3 – 12-GAUGE 2¾" AND 3"					
10322	26"	Black synthetic	47.5"	6.8 lbs.	\$1949
10317	28"	Black synthetic	49.5"	6.9 lbs.	\$1949
10309	28"	Realtree® Max-7™	49.5"	6.9 lbs.	\$2049
10362	28"	GORE™ OPTIFADE™ Timber	49.5"	6.9 lbs.	\$2049
10353	28"	Mossy Oak® Bottomland™	49.5"	6.9 lbs.	\$2049
11240	28"	Marsh/Patriot Brown	49.5"	6.9 lbs.	\$2149
11241	28"	Timber/Tungsten	49.5"	6.9 lbs.	\$2149

SUPER BLACK EAGLE 3 COMPACT – 12-GAUGE 2¾" AND 3"

NEW! 11320	26"	Black synthetic	46.25"	6.7 lbs.	\$1949
-------------------	-----	-----------------	--------	----------	--------

COMMON SPECIFICATIONS: Magazine Capacity: 3+1 Crio® Flush Chokes: C,IM,F Crio® Extended Chokes: IC,M Type of Sights: Red-bar front sight Length of Pull: 14½" (Compact: 13½") Drop at Heel: 2¼" Drop at Comb: 1¼" Minimum recommended load: 3-dram, 1½-oz. loads (12-ga.) †Receiver drilled and tapped for scope mounting.

STANDARD FEATURES

- EXTENDED CHOKE TUBES:** IC, M, Crio® chokes.
- FLUSH CHOKE TUBES:** C, IM, F Crio® chokes and wrench.
- FINISHES:** Realtree® Max-7, Black synthetic, Mossy Oak® Bottomland,™ GORE™ OPTIFADE™ Timber, GORE™ OPTIFADE™ Timber/Tungsten Cerakote, GORE™ OPTIFADE™ Marsh/Patriot Brown Cerakote.
- BARRELS:** Crio®-treated barrel.
- RECOIL PADS:** Comfortech® 3 recoil pads and Combtch pads.
- SHIM KIT:** For adjustment of drop and cast.
- HARD CASE:** Custom fitted hard case to protect during transport.

OPTIONAL FEATURES

- CHOKE TUBES:** Extended Crio® chokes C, IM, F and XF for turkey.
- COMFORTECH 3 RECOIL PADS:** Three options to customize length of pull to 13¾", 14¾" or 14¾"
- COMB-TECH® RAISED COMB PADS:** Two options to customize sight plane for different shooting scenarios.



SUPER BLACK EAGLE 3 – 12-GA, 3"
ITEM # 11241 GORE™ OPTIFADE™ Waterfowl Timber, Tungsten Cerakote



SUPER BLACK EAGLE 3 – 12-GA, 3"
ITEM # 11240 GORE™ OPTIFADE™ Marsh, Patriot Brown Cerakote

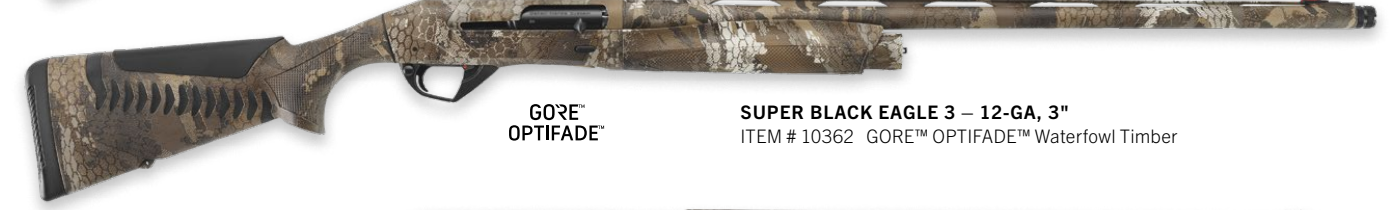

GORE™ OPTIFADE™
SUPER BLACK EAGLE 3 – 12-GA, 3"
ITEM # 10362 GORE™ OPTIFADE™ Waterfowl Timber

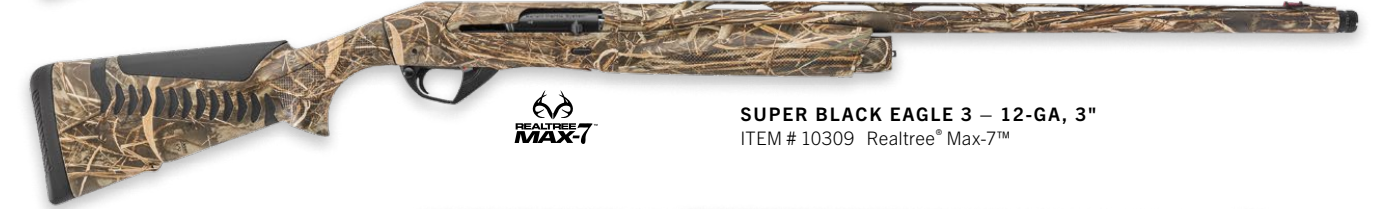

REALTREE MAX-7
SUPER BLACK EAGLE 3 – 12-GA, 3"
ITEM # 10309 Realtree® Max-7™



NEW! **SUPER BLACK EAGLE 3 COMPACT – 12-GA, 3"**
ITEM # 11320 Black synthetic

SBE3

20 - GAUGE
3" CHAMBER



GORE
OPTIFADE™

SUPER BLACK EAGLE 3 – 20-GA, 3"
ITEM # 10342 GORE™ OPTIFADE™ Waterfowl Timber

INERTIA DRIVEN
SYSTEM

COMFORTECH 3

When wave after wave of ducks are settling into your decoys or flocks of low-flying doves come in one after another, you'll appreciate the lighter recoil of a 20-gauge shotgun. Benelli's Super Black Eagle shotguns have been dominating such situations for a generation, and the 20-gauge SBE3 is perfect for both high-volume shooters and hunters who are a bit more recoil sensitive. This shotgun delivers all the performance, reliability and comfort features of the 3.5"-chambered SBEs in a 20-gauge model able to shoot 3" and 2-3/4" shells. It's lightweight, smooth-swinging, quick and a joy to shoot all day long.



SUPER BLACK EAGLE 3

ITEM NUMBER	BARREL LENGTH	FINISH	OVERALL LENGTH	AVERAGE WEIGHT	MSRP
SUPER BLACK EAGLE 3 BE.S.T. – 20-GAUGE 2 3/4" AND 3"					
12103	26"	Black synth./BE.S.T.	47.5"	5.8 lbs.	\$2299
12104	28"	Black synth./BE.S.T.	49.5"	5.9 lbs.	\$2299
SUPER BLACK EAGLE 3 – 20-GAUGE 2 3/4" AND 3"					
10340	26"	Black synthetic	47.5"	5.8 lbs.	\$1949
10341	28"	Black synthetic	49.5"	5.9 lbs.	\$1949
10348	26"	Realtree® Max-7™	47.5"	5.8 lbs.	\$2049
10349	28"	Realtree® Max-7™	49.5"	5.9 lbs.	\$2049
10342	26"	GORE™ OPTIFADE™ Timber	47.5"	5.8 lbs.	\$2049
10343	28"	GORE™ OPTIFADE™ Timber	49.5"	5.9 lbs.	\$2049
10346	26"	Mossy Oak® Bottomland™	47.5"	5.8 lbs.	\$2049
10347	28"	Mossy Oak® Bottomland™	49.5"	5.9 lbs.	\$2049
11242	28"	Marsh/Patriot Brown	49.5"	5.9 lbs.	\$2149
11243	28"	Timber/Tungsten	49.5"	5.9 lbs.	\$2149
SUPER BLACK EAGLE 3 COMPACT – 20-GAUGE 2 3/4" AND 3"					
NEW! 11330	26"	Black synthetic	46.25"	5.7 lbs.	\$1949

COMMON SPECIFICATIONS: Magazine Capacity: 3+1 Crio® Flush Chokes: C,IM,F Crio® Extended Chokes: IC,M Type of Sights: Red-bar front sight Length of Pull: 14 1/4" (Compact: 13 1/4") Drop at Heel: 2 1/4" Drop at Comb: 1 1/4" Min. recommended load: 2 1/2-dram, 1/4-oz. loads



SUPER BLACK EAGLE 3 – 20-GA, 3"
ITEM # 11243 GORE™ OPTIFADE™ Waterfowl Timber, Tungsten Cerakote



SUPER BLACK EAGLE 3 – 20-GA, 3"
ITEM # 11242 GORE™ OPTIFADE™ Marsh, Patriot Brown Cerakote



SUPER BLACK EAGLE 3 – 20-GA, 3"
ITEM # 10349 Realtree® Max-7™



SUPER BLACK EAGLE 3 – 20-GA, 3"
ITEM # 10346 Mossy Oak® Bottomland™



NEW! **SUPER BLACK EAGLE 3 COMPACT – 20-GA, 3"**
ITEM # 11330 Black synthetic

STANDARD FEATURES

EXTENDED CHOKE TUBES: IC, M, Crio® chokes.
FLUSH CHOKE TUBES: C, IM, F Crio® chokes and wrench.
FINISHES: Realtree® Max-7, Black synthetic, Black synth./BE.S.T. Mossy Oak® Bottomland,™ GORE™ OPTIFADE™ Timber, GORE™ OPTIFADE™ Timber/Tungsten Cerakote, GORE™ OPTIFADE™ Marsh/Patriot Brown Cerakote.
BARRELS: Crio®-treated barrel.
RECOIL PADS: Comfortech® 3 recoil pads and Combtech pads.
SHIM KIT: For adjustment of drop and cast.
HARD CASE: Custom fitted hard case to protect during transport.

OPTIONAL FEATURES

CHOKE TUBES: Extended Crio® chokes C, IM, F and XF for turkey.
COMFORTECH 3 RECOIL PADS: Three options to customize length of pull to 13 7/8", 14 3/8" or 14 3/4"
COMB-TECH® RAISED COMB PADS: Two options to customize sight plane for different shooting scenarios.

SBE 3

28 - GAUGE
3" CHAMBER



SUPER BLACK EAGLE 3 – 28-GA, 3"
ITEM # 10339 Realtree® Max-7™

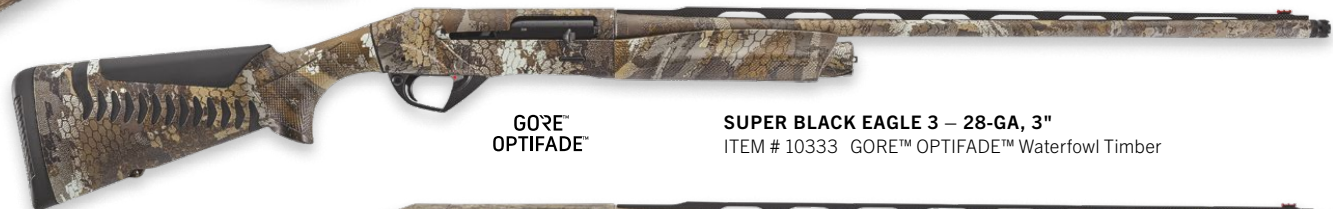

**GORE™
OPTIFADE™**

SUPER BLACK EAGLE 3 – 28-GA, 3"
ITEM # 10333 GORE™ OPTIFADE™ Waterfowl Timber



MOSSY OAK

SUPER BLACK EAGLE 3 – 28-GA, 3"
ITEM # 10337 Mossy Oak® Bottomland™



NEW! **SUPER BLACK EAGLE 3 COMPACT – 28-GA, 3"**
ITEM # 11340 Black synthetic

SUPER BLACK EAGLE 3

ITEM NUMBER	BARREL LENGTH	STOCK	OVERALL LENGTH	AVERAGE WEIGHT	MSRP
SUPER BLACK EAGLE 3 BE.S.T. – 28-GAUGE 2¾" AND 3"					
12105	26"	Black synthetic	47.5"	5.5 lbs.	\$2299
12106	28"	Black synthetic	49.5"	5.6 lbs.	\$2299
SUPER BLACK EAGLE 3 – 28-GAUGE 2¾" AND 3"					
10330	26"	Black synthetic	47.5"	5.5 lbs.	\$1949
10331	28"	Black synthetic	49.5"	5.6 lbs.	\$1949
10338	26"	Realtree® Max-7™	47.5"	5.5 lbs.	\$2049
10339	28"	Realtree® Max-7™	49.5"	5.6 lbs.	\$2049
10332	26"	GORE™ OPTIFADE™ Timber	47.5"	5.5 lbs.	\$2049
10333	28"	GORE™ OPTIFADE™ Timber	49.5"	5.6 lbs.	\$2049
10336	26"	Mossy Oak® Bottomland™	47.5"	5.5 lbs.	\$2049
10337	28"	Mossy Oak® Bottomland™	49.5"	5.6 lbs.	\$2049
SUPER BLACK EAGLE 3 COMPACT – 28-GAUGE 2¾" AND 3"					
NEW! 11340	26"	Black synthetic	46.25"	5.4 lbs.	\$1949

STANDARD FEATURES

EXTENDED CHOKE TUBES: IC, M, Crio® chokes.
FLUSH CHOKE TUBES: C, IM, F Crio® chokes and wrench.
FINISHES: Realtree® Max-7, Black synthetic, Mossy Oak® Bottomland™, GORE™ OPTIFADE™ Timber, BARRELS: Crio®-treated barrel.
RECOIL PADS: Comfort Tech® 3 recoil pads and Combtech pads.
SHIM KIT: For adjustment of drop and cast.
HARD CASE: Custom fitted hard case to protect during transport.

OPTIONAL FEATURES

CHOKE TUBES: Extended Crio® chokes C, IM, F and XF for turkey.
COMFORTECH 3 RECOIL PADS: Three options to customize length of pull to 13⁷/₈", 14³/₈" or 14³/₄"
COMB-TECH® RAISED COMB PADS: Two options to customize sight plane for different shooting scenarios.

COMMON SPECIFICATIONS: Magazine Capacity: 2+1 Crio® Flush Chokes: C, IM, F Crio® Extended Chokes: IC, M Type of Sights: Red-bar front sight Length of Pull: 14¹/₄" (Compact: 13¹/₄") Drop at Heel: 2¹/₄" Drop at Comb: 1¹/₄" Min. recommended load: ¾-oz. loads (28-ga.)



An upsized bolt handle teams with an enlarged bolt release and oversized safety to make operation easier with cold or gloved hands.



Each SBE 3 comes complete with two Crio extended chokes (one pre-installed), three flush-mount Crio chokes, a shim kit, a choke wrench and a custom-fitted hard case.

The sub-gauge wave is sweeping the hunting community, and Benelli is on top of it with this new 28-gauge offering of our renowned Super Black Eagle. If you hunt in an area that requires use of smaller gauges, or just want the added challenge they offer, this is the shotgun for you! It delivers all the rugged reliability, performance and shooting comfort of larger SBE-3s, along with all the Benelli technology and comfort features, in a super-light and fast-handling shotgun that's downright addicting to shoot. Available in your choice of three camo patterns or black. Shoots both 3" and 2-¾" shells.



The SBE 3 28-gauge models include a carbon-fiber rib and a fiber-optic red-bar front sight.

Ethos

The Perfect Balance of Art and Technology



ETHOS – 28-GA, 3"
ITEM # 10480 AA-Grade satin walnut

 **PROGRESSIVE COMFORT**

 **INERTIA DRIVEN SYSTEM**

ETHOS



ETHOS – 12-GA, 3"
ITEM # 10461 AA-Grade satin walnut



ETHOS – 20-GA, 3"
ITEM # 10472 AA-Grade satin walnut

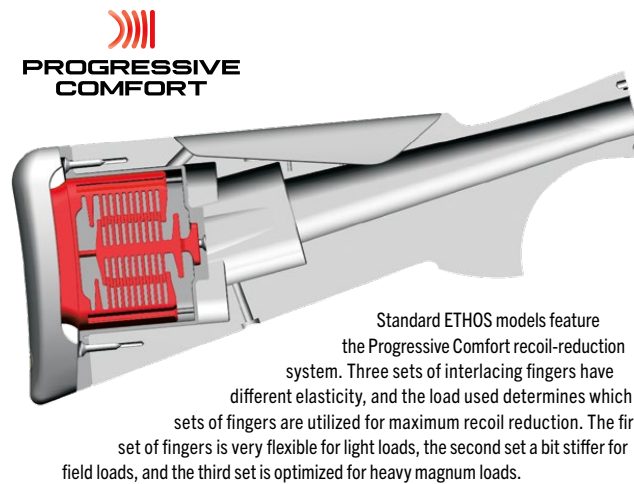

28-GAUGE MAGNUM LOAD ENERGY COMPARISON

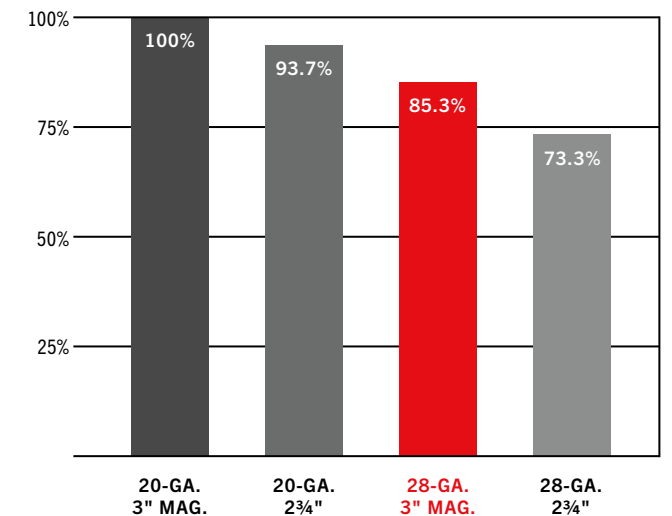

Benelli's dynamic design includes a patented easy-loading system that features a new two-part carrier latch, beveled loading port and redesigned carrier that ensures shells will glide into the magazine faster and easier. A new larger bolt release, easy access cartridge-drop lever and larger trigger guard promote quick handling, even when wearing gloves.

28-GAUGE, 3-INCH MAGNUM LOAD

This cartridge gives you the same velocity as a standard 2¾" 28-ga. load but with ¼ oz. more shot. The result is a 25% increase in knockdown power and 20% more pellets on target at 35 yards, giving you that extra edge for late-season birds. With the Progressive Comfort system of the ETHOS soaking up any additional recoil, you get the ballistic advantage of a 20-ga. in an easy handling 28-ga. package.

The ETHOS, an elegant semi-automatic shotgun, is the culmination of Benelli's latest innovations, refinements and design superiority, all centered around the core—our Inertia Driven® System. The ETHOS is built on a platform that combines form and function for improved ergonomics, the ability to cycle the lightest loads, even ⅞ ounce (12-ga.), and patented recoil systems to provide greater recoil reduction.

STANDARD FEATURES

- CHOKE TUBES:** C, IC, M, IM, F Crio® choke tubes and wrench.
- FINISH:** AA-Grade satin walnut.
- RECEIVER:** Engraved nickel-plated.
- SHIM KIT:** For adjustment of drop and cast.
- HARD CASE:** Custom-fitted hard case to protect during transport.

OPTIONAL FEATURES

- CHOKE TUBES:** Extended chrome Crio® choke tubes C, IC, M, IM, F.

ETHOS

ITEM NUMBER	BARREL LENGTH	STOCK	OVERALL LENGTH	AVERAGE WEIGHT	MSRP
ETHOS 12-GAUGE 2¾" AND 3" – ENGRAVED NICKEL-PLATED RECEIVER					
10461	26"	AA-Grade satin walnut	47.5"	6.6 lbs.	\$2299
10462	28"	AA-Grade satin walnut	49.5"	6.7 lbs.	\$2299
ETHOS 20-GAUGE 2¾" AND 3" – ENGRAVED NICKEL-PLATED RECEIVER					
10471	26"	AA-Grade satin walnut	47.5"	5.6 lbs.	\$2299
10472	28"	AA-Grade satin walnut	49.5"	5.7 lbs.	\$2299
ETHOS 28-GAUGE 2¾" AND 3" – ENGRAVED NICKEL-PLATED RECEIVER					
10480	26"	AA-Grade satin walnut	47"	5.5 lbs.	\$2299

COMMON SPECIFICATIONS: Magazine Capacity: 4+1 (2+1 28-Ga.) Crio® Chokes: C, IC, M, IM, F
Type of Sights: Interchangeable fiber-optic front sight with red, green and yellow inserts
Length of Pull: 14¼" **Drop at Heel:** 2¼" **Drop at Comb:** 1½" Minimum recommended load: ⅞-oz. loads, ¾-oz. 28-ga. *28-ga. does not have interchangeable sights.

SPECIFICATIONS AND PRICES SUBJECT TO CHANGE WITHOUT NOTICE.

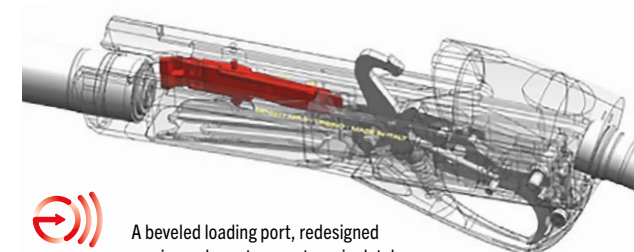

EASY LOADING
A beveled loading port, redesigned carrier and new two-part carrier latch make loading the magazine effortless.

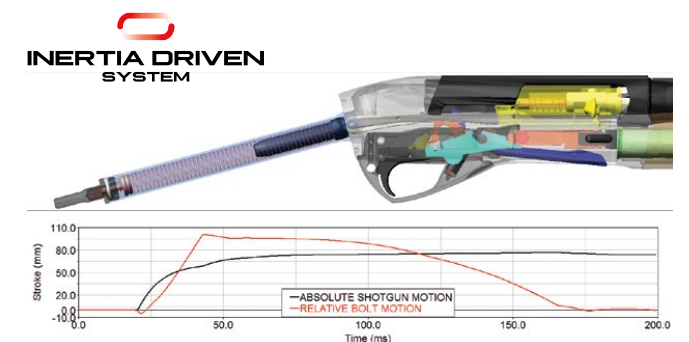

Ethos Cordoba BE.S.T.
Where Style and Excellence Meet



BE.S.T.

ETHOS CORDOBA BE.S.T. – 20-GA, 3"
ITEM # 10643 Black synthetic
(See pages 2-5 for details on BE.S.T. technology)

Sporting a sleek profile and equipped with the latest Benelli technology, our ETHOS Cordoba BE.S.T. shotguns deliver unmatched semiautomatic performance. Ported barrels team with our ComforTech® recoil-reduction system to make shooting a pleasurable experience. Our proven Inertia Driven® System ensures flawless reliability in any weather when cycling anything from heavy 3-inch 12-ga. magnums to the lightest 7/8 ounce loads. Each has a beveled loading port to promote fast reloading. A large bolt handle and enhanced trigger guard aid shooters wearing gloves. Benelli Surface Treatment (BE.S.T.) on external metal surfaces offers a level of protection from rust and corrosion that competing surface treatments can only aspire to.

ETHOS



A wide Broadway sight channel on the carbon-fiber rib of the ETHOS Cordoba BE.S.T. works with fiber-optic and mid-rib beads to guide your eye to the target quickly.



ETHOS CORDOBA BE.S.T. – 12-GA, 3"
ITEM # 10641 Black synthetic

ETHOS Cordoba BE.S.T. models feature ported barrels and BE.S.T. treated, extended chokes.



ETHOS CORDOBA BE.S.T. – 28-GA, 3"
ITEM # 10644 Black synthetic



Our Shell View system is included with ETHOS Cordoba models. Small windows in the magazine tube are visible through a slot in the forend, enabling you to see how many shells are loaded in the tube. A red follower/indicator in the picture above shows there are four shells in the magazine tube.

STANDARD FEATURES

- EXTENDED CHOKE TUBES: C, IC, M, IM, F Crio® chokes.
- FINISH: Black synthetic.
- RECEIVER: Anodized.
- BARREL: BE.S.T.-treated, Ported
- SHIM KIT: For adjustment of drop and cast.
- SHELL VIEW
- HARD CASE: Custom-fitted hard case to protect during transport.

OPTIONAL FEATURES

- CHOKE TUBES: Extended chrome Crio® choke tubes C, IC, M, IM, F; C, IC, M, IM, F Crio® flush choke tubes.

ETHOS CORDOBA

ITEM NUMBER	BARREL LENGTH	STOCK	OVERALL LENGTH	AVERAGE WEIGHT	MSRP
ETHOS CORDOBA BE.S.T. – 12-GAUGE 2¾" AND 3"					
10641	28"	Black synthetic	49.5"	6.9 lbs.	\$2549
ETHOS CORDOBA BE.S.T. – 20-GAUGE 2¾" AND 3"					
10643	28"	Black synthetic	49.5"	5.9 lbs.	\$2549
ETHOS CORDOBA BE.S.T. – 28-GAUGE 2¾" AND 3"					
10644	28"	Black synthetic	49"	5.4 lbs.	\$2549

COMMON SPECIFICATIONS: Magazine Capacity: 4+1 (2+1 28-Ga.) Extended Crio® Chokes: C, IC, M, IM, F Type of Sights: Fiber-optic front sight with red insert Length of Pull: 14½" Drop at Heel: 2¼" Drop at Comb: 1½" Minimum recommended load: 7/8-oz. loads, ¾-oz. 28-ga.

SPECIFICATIONS AND PRICES SUBJECT TO CHANGE WITHOUT NOTICE.

Ethos SuperSport Big Performance, Small Recoil



 INERTIA DRIVEN SYSTEM

ETHOS

The ETHOS SuperSport combines the excellence of our popular ETHOS Sport model with a new, lightweight, weather-resistant carbon-fiber finish for unmatched performance in any weather. The synthetic stock accommodates our ComforTech 3 recoil-reduction system that teams with a ported barrel to mitigate recoil and muzzle jump. A fiber-optic front sight with a red insert, combines with a mid-rib bead inside a sight channel atop the wide rib to offer instinctive aiming. A beveled loading port speeds reloading. Five extended choke tubes are included to facilitate quick changes in the heat of competition.

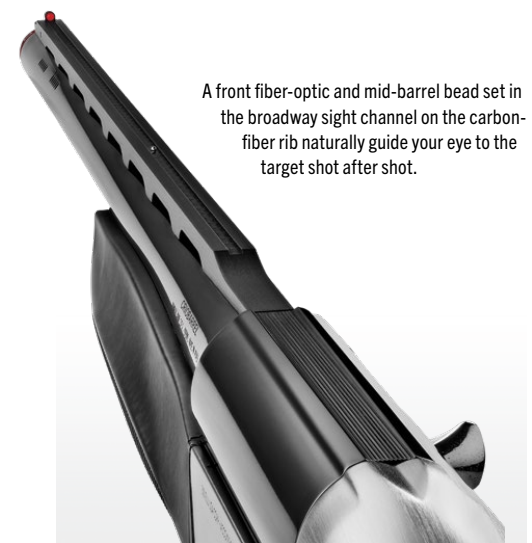

A front fiber-optic and mid-barrel bead set in the Broadway sight channel on the carbon-fiber rib naturally guide your eye to the target shot after shot.

ETHOS SUPERSPORT – 12-GA, 3"
ITEM # 10631 Carbon-fiber finish



ETHOS SuperSport models feature ported barrels and extended chokes.

ETHOS SUPERSPORT – 20-GA, 3"
ITEM # 10633 Carbon-fiber finish

 COMFORTTECH 3

 Combtch

STANDARD FEATURES

- EXTENDED CHROME CHOKE TUBES:** C, IC, M, IM, F Crio® chokes.
- FINISH:** Carbon-fiber finish.
- RECEIVER:** Nickel-plated.
- BARREL:** Gloss blue, Ported
- SHIM KIT:** For adjustment of drop and cast.
- SHELL VIEW**
- HARD CASE:** Custom-fitted hard case to protect during transport.

OPTIONAL FEATURES

- CHOKE TUBES:** Extended black Crio® choke tubes C, IC, M, IM, F; C, IC, M, IM, F Crio® flush choke tubes.

ETHOS SUPERSPORT

ITEM NUMBER	BARREL LENGTH	STOCK	OVERALL LENGTH	AVERAGE WEIGHT	MSRP
ETHOS SUPERSPORT – 12-GAUGE 2¾" AND 3"					
10631	28"	Carbon-fiber finish	49.5"	6.9 lbs.	\$2349
10632	30"	Carbon-fiber finish	51.5"	7.0 lbs.	\$2349
ETHOS SUPERSPORT – 20-GAUGE 2¾" AND 3"					
10633	28"	Carbon-fiber finish	49.5"	5.9 lbs.	\$2349

COMMON SPECIFICATIONS: Magazine Capacity: 4+1 (2+1 28-Ga.) Extended Crio® Chrome Chokes: C, IC, M, IM, F Type of Sights: Fiber-optic front sight with red insert Length of Pull: 14¼" Drop at Heel: 2¼" Drop at Comb: 1½" Minimum recommended load: 7/8-oz. loads
SPECIFICATIONS AND PRICES SUBJECT TO CHANGE WITHOUT NOTICE.



ETHOS SuperSport models feature our Shell View system to provide fast and easy visual inspection of how many shells are loaded in the magazine tube. The red follower/indicator in the picture above shows there are four shells in the magazine tube.

Ethos Sport
A Clay-Busting Machine
in an Elegant Package



ETHOS Sport

 **INERTIA DRIVEN SYSTEM**

ETHOS – 12-GA, 3"
ITEM # 10495 AA-Grade satin walnut



 **PROGRESSIVE COMFORT**

ETHOS – 20-GA, 3"
ITEM # 10455 AA-Grade satin walnut

Benelli is a company of avid shotgunners who never stop thinking about new and innovative ways to make our products even better. The sporting version of the ETHOS perfectly embodies this "ethos." Using the popular field model as a basis, we refined the recoil-absorbing cheek-comb pad, raised the wide sporting rib, and outfitted the barrel with porting to get your second shot on target quickly. Available in 12- and 20-gauge models, it cycles even the lightest target loads (e.g., 7/8 oz. in 12-gauge).

ETHOS SPORT

ITEM NUMBER	BARREL LENGTH	STOCK	OVERALL LENGTH	AVERAGE WEIGHT	MSRP
ETHOS 12-GAUGE 2¾" AND 3" – NICKEL-PLATED RECEIVER					
10495	30"	AA-Grade satin walnut	51.5"	6.7 lbs.	\$2349
ETHOS 20-GAUGE 2¾" AND 3" – NICKEL-PLATED RECEIVER					
10455	28"	AA-Grade satin walnut	49.5"	5.7 lbs.	\$2349

COMMON SPECIFICATIONS: Magazine Capacity: 4+1 (2+1 28-ga.) Extended Crio® Chokes: C, IC, M, IM, F Type of Sights: Fiber-optic front sight with red insert and metal bead mid-sight Length of Pull: 14¼" Drop at Heel: 2¼" Drop at Comb: 1½" Minimum recommended load: 7/8-oz. loads

SPECIFICATIONS AND PRICES SUBJECT TO CHANGE WITHOUT NOTICE.

STANDARD FEATURES

- EXTENDED CHOKE TUBES:** C, IC, M, IM, F Crio® choke tubes and wrench.
- FINISH:** AA-Grade satin walnut.
- RECEIVER:** Nickel-plated.
- SHIM KIT:** For adjustment of drop and cast.
- HARD CASE:** Custom-fitted hard case to protect during transport.

OPTIONAL FEATURES

- CHOKE TUBES:** Flush chrome Crio® choke tubes C, IC, M, IM, F.



Extended choke tubes optimize patterns and are quickly changed in the heat of competition. Porting minimizes barrel jump, and the high-visibility sight makes lining up your shot easy.



The rib of the ETHOS Sport has some substantial differences from its field counterpart. It is not only wider and higher, but also features a smooth-textured central "sight channel" that naturally guides your eye to the target.

M2 Field

Workhorse Rugged with Thoroughbred Speed



M2 FIELD – 12-GA, 3" ITEM # 11165 Realtree® Max-7™



Rugged, fast and relentlessly reliable, the M2 Field is the legendary workhorse of the Benelli line of semi-automatic shotguns. Known for its ability to flawlessly cycle everything from light 2¾" target loads to heavy 3" magnums, the M2 is a popular choice for waterfowlers and turkey hunters alike. Available in 12- and 20-gauge with 24-, 26-, or 28-inch barrels and a variety of synthetic stock options.

M2 Field 20-Gauge Models

M2 FIELD – 20-GA, 3" ITEM # 11180 GORE™ OPTIFADE™ Waterfowl Timber



M2 FIELD – 20-GA, 3" ITEM # 11176 Mossy Oak® Bottomland™



M2 FIELD – 20-GA, 3" ITEM # 11174 Black synthetic



M2 FIELD – 12-GA, 3" ITEM # 11167 GORE™ OPTIFADE™ Waterfowl Timber



M2 FIELD – 12-GA, 3" ITEM # 11169 Mossy Oak® Bottomland™



M2 FIELD COMPACT – 12-GA, 3" ITEM # 11170 Black synthetic

M2 FIELD 12-GAUGE

ITEM NUMBER	BARREL LENGTH	STOCK	OVERALL LENGTH	AVERAGE WEIGHT	MSRP
M2 FIELD 12-GAUGE 2¾" AND 3"					
11160	24"	Black synthetic	45.5"	6.6 lbs.	\$1499
11161	26"	Black synthetic	47.5"	6.7 lbs.	\$1499
11162	28"	Black synthetic	49.5"	6.8 lbs.	\$1499
11164	26"	Realtree® Max-7™	47.5"	6.7 lbs.	\$1599
11165	28"	Realtree® Max-7™	49.5"	6.8 lbs.	\$1599
11166	26"	GORE™ OPTIFADE™ Timber	47.5"	6.7 lbs.	\$1599
11167	28"	GORE™ OPTIFADE™ Timber	49.5"	6.8 lbs.	\$1599
11168	26"	Mossy Oak® Bottomland™	47.5"	6.7 lbs.	\$1599
11169	28"	Mossy Oak® Bottomland™	49.5"	6.8 lbs.	\$1599
M2 FIELD COMPACT 12-GAUGE 2¾" AND 3"					
11170	26"	Black synthetic	46.25"	6.6 lbs.	\$1499
LEFT-HAND M2 FIELD CLASSIC STYLING 12-GAUGE 2¾" AND 3"					
11071	28"	Black synth., ComforTech™	49.5"	7.2 lbs.	\$1499



COMMON SPECIFICATIONS: Magazine Capacity: 3+1 Crio® Chokes: IC, M, F Type of Sights: Red-bar front sight Length of Pull: 14¼" (Compact: 13¼") Drop at Heel: 2¼" (Compact: 2") Drop at Comb: 1¼" (Compact: 1¼") Minimum recommended load: 3-dram, 1¼-oz. loads (12-ga.).

M2 FIELD 20-GAUGE

ITEM NUMBER	BARREL LENGTH	STOCK	OVERALL LENGTH	AVERAGE WEIGHT	MSRP
M2 FIELD 20-GAUGE 2¾" AND 3"					
11184	24"	Black synthetic	45.5"	5.8 lbs.	\$1499
11173	26"	Black synthetic	47.5"	5.9 lbs.	\$1499
11174	28"	Black synthetic	49.5"	6.0 lbs.	\$1499
11177	26"	Realtree® Max-7™	47.5"	5.9 lbs.	\$1599
11178	28"	Realtree® Max-7™	49.5"	6.0 lbs.	\$1599
11179	26"	GORE™ OPTIFADE™ Timber	47.5"	5.9 lbs.	\$1599
11180	28"	GORE™ OPTIFADE™ Timber	49.5"	6.0 lbs.	\$1599
11175	26"	Mossy Oak® Bottomland™	47.5"	5.9 lbs.	\$1599
11176	28"	Mossy Oak® Bottomland™	49.5"	6.0 lbs.	\$1599
M2 FIELD COMPACT 20-GAUGE 2¾" AND 3"					
11172	24"	Black synthetic	44.25"	5.7 lbs.	\$1499
11182	24"	Realtree® Max-7™	44.25"	5.7 lbs.	\$1599
LEFT-HAND M2 FIELD CLASSIC STYLING 20-GAUGE 2¾" AND 3"					
11195	26"	Black synth., ComforTech™	47.3"	5.8 lbs.	\$1499



COMMON SPECIFICATIONS: Magazine Capacity: 3+1 Crio® Chokes: IC, M, F Type of Sights: Red-bar front sight Length of Pull: 14¼" (Compact: 13¼") Drop at Heel: 2¼" (Compact: 2") Drop at Comb: 1¼" (Compact: 1¼") Minimum recommended load: 2¼-dram, ¼-oz. loads (20-ga.).



The corrosion-resistant recoil tube and stainless steel spring can be accessed easily by removing the quick-detachable ergonomic recoil pad.

STANDARD FEATURES

CHOKE TUBES: Crio® IC, M, F chokes and wrench.
FINISHES: Realtree® Max-7™, GORE™ OPTIFADE™ Timber, Mossy Oak® Bottomland™ or Black synthetic.
MICRO CELL RECOIL PAD: Helps reduce felt recoil.
SHIM KIT: For adjustment of drop and cast.

OPTIONAL FEATURES

CHOKE TUBES: Extended chokes for pass shooting (IM), shooting waterfowl over decoys (IC), and for turkey hunting (XF) (12-gauge only). Extended Crio® chokes C, IC, M, IM, F.
MICRO CELL RECOIL PADS: Three options to customize length of pull to 13⅞", 14⅜" or 14¾".

SPECIFICATIONS AND PRICES
 SUBJECT TO CHANGE WITHOUT NOTICE.

Montefeltro

A Sleek, Fast-Shooting Classic



MONTEFELTRO – 20-GA, 3"
ITEM # 10885 Satin walnut

Our sharp-looking Montefeltro semi-automatic shotgun has been a favorite of upland hunters and clays shooters for years. Now it's available in six different configurations to suit shooters of all shapes, sizes and experience levels. Its sleek profile and handsome walnut stock pair nicely with the deep gloss-blue finish on the receiver and barrel. Built on Benelli's legendary Inertia-Driven® System, the Montefeltro offers outstanding performance and exceptional reliability. Choose 12- or 20-gauge, each of which comes in two barrel lengths and a compact model for small-statured shooters.



MONTEFELTRO – 12-GA, 3"
ITEM # 10881 Satin walnut



MONTEFELTRO

STANDARD FEATURES

CHOKE TUBES: IC, M, F Crio® choke tubes and wrench.

FINISH: Satin walnut.

MICRO CELL RECOIL PAD: Helps reduce felt recoil.

SHIM KIT: For adjustment of drop and cast.

OPTIONAL FEATURES

CHOKE TUBES: Extended Crio® chokes for pass shooting(M), shooting waterfowl over decoys (IC) and for turkey (XF) (12-gauge only). Plus Extended Crio® chokes C, IC, M, IM, F.

SPECIFICATIONS AND PRICES
SUBJECT TO CHANGE WITHOUT NOTICE.

MONTEFELTRO

ITEM NUMBER	BARREL LENGTH	STOCK	OVERALL LENGTH	AVERAGE WEIGHT	MSRP
MONTEFELTRO 12-GAUGE 2¾" AND 3"					
10881	26"	Satin walnut	47.5"	6.5 lbs.	\$1599
10882	28"	Satin walnut	49.5"	6.6 lbs.	\$1599
MONTEFELTRO COMPACT 12-GAUGE 2¾" AND 3"					
10887	26"	Satin walnut	46.25"	6.3 lbs.	\$1599
MONTEFELTRO 20-GAUGE 2¾" AND 3"					
10884	26"	Satin walnut	47.5"	5.8 lbs.	\$1599
10885	28"	Satin walnut	49.5"	5.9 lbs.	\$1599
MONTEFELTRO COMPACT 20-GAUGE 2¾" AND 3"					
10886	24"	Satin walnut	44.25"	5.3 lbs.	\$1599
LEFT-HAND MONTEFELTRO CLASSIC STYLING 12-GA. 2¾" AND 3"					
10863	26"	Satin walnut	47.5"	6.9 lbs.	\$1299
10864	28"	Satin walnut	49.5"	7.1 lbs.	\$1299



COMMON SPECIFICATIONS: Magazine Capacity: 4+1 Crio® Chokes: IC,M,F Type of Sights: Red-bar front sight Length of Pull: 14¼" (compact 12¼") Drop at Heel: 2¼" (compact 2¼") Drop at Comb: 1¼" Minimum recommended load: 3-dram, 1¼-oz. loads (12-ga.). 2¼-dram, ¾-oz. loads (20-ga.).

Montefeltro Sporting

Smooth-Swinging, Fast-Shooting

NEW!



INERTIA DRIVEN SYSTEM **MONTEFELTRO SPORTING – 20-GA, 3"**
ITEM # 10896 A-Grade satin walnut

The perfect on-ramp to Benelli's renowned clay and field shotguns, the new Montefeltro Sporting combines an ergonomic, slim forend and exceptional balance with 30-in. (12-ga.) or 28-in. (20-ga.) barrels to deliver a clay and dove buster designed for comfortable, all-day shooting. The high-profile stepped vent rib and mid-bead allows an elevated hold, promoting good eye alignment and enhanced visibility on fast-moving targets while the ported barrel mitigates recoil for lightning-quick follow-up shots. Balanced for smooth, clean swings, the Montefeltro Sporting is your gateway to the Benelli experience.

INERTIA DRIVEN SYSTEM **MONTEFELTRO SPORTING – 12-GA, 3"**
ITEM # 10891 A-Grade satin walnut

MONTEFELTRO SPORTING

ITEM NUMBER	BARREL LENGTH	STOCK	OVERALL LENGTH	AVERAGE WEIGHT	MSRP
MONTEFELTRO SPORTING 12-GAUGE 2¾" AND 3"					
10891	30"	A-Grade Satin walnut	51.5"	6.7 lbs.	\$1649
MONTEFELTRO SPORTING 20-GAUGE 2¾" AND 3"					
10896	28"	A-Grade Satin walnut	49.5"	5.9 lbs.	\$1649

COMMON SPECIFICATIONS: Magazine Capacity: 4+1 Extended Crio® Chokes: IC, M, F
Type of Sights: Red-bar front sight Length of Pull: 14¼" Drop at Heel: 2¼" Drop at Comb: 1¼"
Minimum recommended load: 3-dram, 1¼-oz. loads (12-ga.). 2½-dram, ¾-oz. loads (20-ga.).

STANDARD FEATURES

EXTENDED CHOKE TUBES: IC, M, F Crio® choke tubes and wrench.
FINISH: A-Grade satin walnut.
GLOSS PORTED CRIO BARREL
GLOSS BLACK ANODIZED RECEIVER
SHIM KIT: For adjustment of drop and cast.

OPTIONAL FEATURES

CHOKE TUBES: Extended Crio® choke tubes C, IM, Pass & Decoy.
Flush Crio® choke tubes C, IC, M, IM, F.

Montefeltro Ultra Light

Featherweight Handling for Field and Bush

NEW!



INERTIA DRIVEN SYSTEM **MONTEFELTRO ULTRA LIGHT – 12-GA, 3"**
ITEM # 10911 AA-Grade satin walnut, WeatherCoat™

When enjoying long days on the prairie or scrambling through the grouse woods, veteran uplanders know that ounces equal pounds. That's why Benelli engineers developed the Montefeltro Ultra Light. Boasting a shortened mag tube (that can be extended when needed) and a carbon-fiber rib with 26-in. (12-ga.) and 24-in. (20-ga.) barrels, the Montefeltro Ultra Light features the Benelli Inertia Driven System, providing effortless cycling of even light loads to further reduce weight so you can stay in the game for "just one more."

INERTIA DRIVEN SYSTEM **MONTEFELTRO ULTRA LIGHT – 20-GA, 3"**
ITEM # 10915 AA-Grade satin walnut, WeatherCoat™

MONTEFELTRO ULTRA LIGHT

ITEM NUMBER	BARREL LENGTH	STOCK	OVERALL LENGTH	AVERAGE WEIGHT	MSRP
MONTEFELTRO ULTRA LIGHT 12-GAUGE 2¾" AND 3"					
10911	26"	AA-Grade Satin walnut	47.6"	6.3 lbs.	\$1949
MONTEFELTRO ULTRA LIGHT 20-GAUGE 2¾" AND 3"					
10915	24"	AA-Grade Satin walnut	45.6"	5.3 lbs.	\$1949

COMMON SPECIFICATIONS: Magazine Capacity: 4+1 Crio® Chokes: C, IC, M
Type of Sights: Red-bar front sight Length of Pull: 14¼" Drop at Heel: 2¼" Drop at Comb: 1¼"
Minimum recommended load: 3-dram, 1¼-oz. loads (12-ga.). 2½-dram, ¾-oz. loads (20-ga.).

STANDARD FEATURES

CHOKE TUBES: C, IC, M Crio® choke tubes and wrench.
FINISH: A-Grade satin walnut.
GLOSS CRIO BARREL
GLOSS BLACK ANODIZED RECEIVER
SHIM KIT: For adjustment of drop and cast.

OPTIONAL FEATURES

CHOKE TUBES: Extended Crio® choke tubes C, IC, M, IM, F, Pass & Decoy.
Flush Crio® choke tubes IM, F.

Montefeltro Silver
Distinctive, Classic Styling

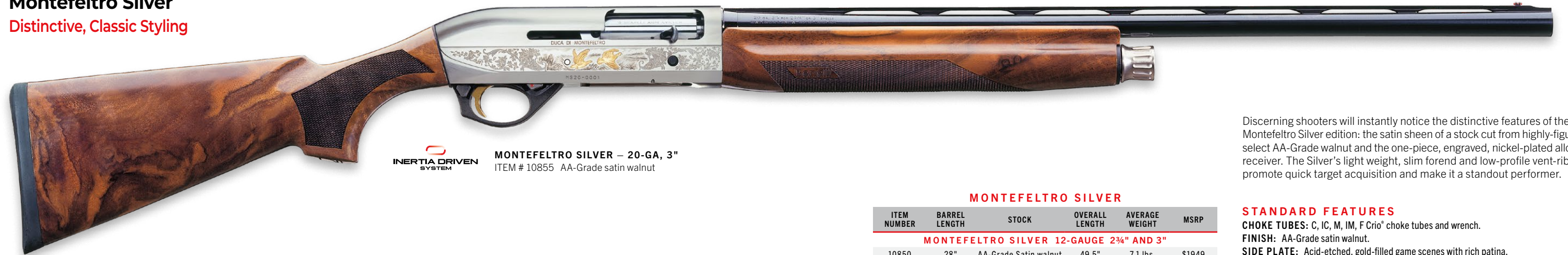

 **MONTEFELTRO SILVER – 20-GA, 3"**
ITEM # 10855 AA-Grade satin walnut



 **MONTEFELTRO SILVER – 12-GA, 3"**
ITEM # 10850 AA-Grade satin walnut

MONTEFELTRO SILVER

ITEM NUMBER	BARREL LENGTH	STOCK	OVERALL LENGTH	AVERAGE WEIGHT	MSRP
MONTEFELTRO SILVER 12-GAUGE 2¾" AND 3"					
10850	28"	AA-Grade Satin walnut	49.5"	7.1 lbs.	\$1949
MONTEFELTRO SILVER 20-GAUGE 2¾" AND 3"					
10855	26"	AA-Grade Satin walnut	47.5"	5.6 lbs.	\$1949

COMMON SPECIFICATIONS: Magazine Capacity: 4+1 Crio® Chokes: C,IC,M,IM,F Type of Sights: Red-bar front sight Length of Pull: 14¼" Drop at Heel: 2¼" Drop at Comb: 1¼" Minimum recommended load: 3-dram, 1¼-oz. loads (12-ga.). 2¼-dram, ¾-oz. loads (20-ga.).

Discerning shooters will instantly notice the distinctive features of the Montefeltro Silver edition: the satin sheen of a stock cut from highly-figured, select AA-Grade walnut and the one-piece, engraved, nickel-plated alloy receiver. The Silver's light weight, slim forend and low-profile vent-rib promote quick target acquisition and make it a standout performer.

STANDARD FEATURES

- CHOKE TUBES:** C, IC, M, IM, F Crio® choke tubes and wrench.
- FINISH:** AA-Grade satin walnut.
- SIDE PLATE:** Acid-etched, gold-filled game scenes with rich patina.
- SHIM KIT:** For adjustment of drop and cast.
- HARD CASE:** Custom-fitted hard case to protect during transport.

OPTIONAL FEATURES

- CHOKE TUBES:** Extended Crio® choke tubes C, IC, M, IM, F, Pass & Decoy.

Montefeltro Silver Featherweight



 **MONTEFELTRO SILVER FW – 20-GA, 3"**
ITEM # 10819 Satin walnut with WeatherCoat™



 **MONTEFELTRO SILVER FW – 12-GA, 3"**
ITEM # 10818 Satin walnut with WeatherCoat™

MONTEFELTRO SILVER FEATHERWEIGHT

ITEM NUMBER	BARREL LENGTH	STOCK	OVERALL LENGTH	AVERAGE WEIGHT	MSRP
MONTEFELTRO SILVER 12-GAUGE 2¾" AND 3"					
10818	26"	Satin walnut WeatherCoat™	47.5"	6.2 lbs.	\$2199
MONTEFELTRO SILVER 20-GAUGE 2¾" AND 3"					
10819	24"	Satin walnut WeatherCoat™	45.6"	5.3 lbs.	\$2199

COMMON SPECIFICATIONS: Magazine Capacity: 2+1 Extended Crio® Chokes: C,IC,M, IM F Type of Sights: Red-bar front sight Length of Pull: 14¼" Drop at Heel: 2¼" Drop at Comb: 1¼" Minimum recommended load: 3-dram, 1¼-oz. loads (12-ga.). 2¼-dram, ¾-oz. loads (20-ga.).

We combined the best features of the Standard Ultralight and Montefeltro Silver shotguns to create these light, quick-handling masterpieces. Satin walnut stocks are treated with weather-resistant WeatherCoat™ and joined with handsome engraving on nickel receivers and blued barrels.

STANDARD FEATURES

- CHOKE TUBES:** C, IC, M, IM, F Extended Crio® (Chrome) chokes and wrench.
- FINISH:** Satin walnut with WeatherCoat™
- SIDE PLATE:** Acid-etched, gold-filled game scenes with rich patina.
- SHIM KIT:** For adjustment of drop and cast.
- HARD CASE:** Custom-fitted hard case to protect during transport.

OPTIONAL FEATURES

- CHOKE TUBES:** Extended Crio® choke tubes C, IC, M, IM, F, Pass & Decoy.

Semi-Auto Defense Guns

Reliability When It Counts The Most



M4 Tactical



M4, TACTICAL STOCK – 12-GA, 3"
ITEM # 11703 Black synthetic, Ghost-ring sight

M4 H₂O, PISTOL GRIP – 12-GA, 3"
ITEM # 11794 Black synthetic, Titanium Cerakote finish, Ghost-ring sight

Benelli's M4 Tactical is a unique Auto Regulating Gas-Operated (A.R.G.O) semi-automatic shotgun, upon which the U.S. Marine Corps depends. The M4 Tactical comes standard with a Picatinny rail and tactical stock. Other features include a fully adjustable ghost-ring aperture rear sight and windage-adjustable front sight. The M4 is also available with a durable, weather-beating Titanium Cerakote finish.

M4 STANDARD FEATURES

CHOKE TUBES: M.
FINISHES: Black synthetic. Titanium Cerakote.
SIGHTS: Ghost-ring.
DRILLED & TAPPED

M4 OPTIONAL FEATURES

TRITIUM INSERTS: Three-dot tritium inserts available for ghost-ring sights.

M4 TACTICAL

ITEM NUMBER	BARREL LENGTH	STOCK	FINISH	OVERALL LENGTH	AVERAGE WEIGHT	MSRP
M4 H₂O TACTICAL†, CERAKOTE FINISH 12-GAUGE 2¾" AND 3"						
11794	18.5"	Pistol Grip	Black synthetic	40"	7.8 lbs.	\$2399
11795	18.5"	Tactical Stock	Black synthetic	40"	7.8 lbs.	\$2399
M4 TACTICAL† 12-GAUGE 2¾" AND 3"						
11703	18.5"	Tactical Stock	Black synthetic	40"	7.8 lbs.	\$2299
11707	18.5"	Pistol Grip	Black synthetic	40"	7.8 lbs.	\$2299

COMMON SPECIFICATIONS: Magazine Capacity: 5+1 Chokes: M Type of Sights: Ghost-ring Length of Pull: 14¼" Drop at Heel: 2¼" Drop at Comb: 1½" †Receiver drilled and tapped for scope mount. Synthetic stock. Picatinny rail is included.

SPECIFICATIONS AND PRICES SUBJECT TO CHANGE WITHOUT NOTICE.

M1014



M1014, FIXED-POSITION SKELETONIZED STOCK – 12-GA, 3"
ITEM # 11701 Black synthetic, Anti-reflective MILSPEC finish, Ghost-ring sight

A civilian version of the shotgun used by the U.S. Marine Corps in combat theaters around the world, the Benelli M1014 sets the standard for military shotgun performance and reliability. The Benelli M1014 comes standard with a fixed-position skeletonized stock with a pistol grip, and separate cheek piece. All the external surfaces are protected with an anti-reflective MILSPEC finish.

M1014 STANDARD FEATURES

CHOKE TUBES: Fixed M.
FINISH: Black synthetic, Anti-reflective MILSPEC finish.
SIGHTS: Ghost-ring.
DRILLED & TAPPED

M1014 OPTIONAL FEATURES

TRITIUM INSERTS: Three-dot tritium inserts available for ghost-ring sights.

M1014†

ITEM NUMBER	BARREL LENGTH	STOCK	FINISH	OVERALL LENGTH	AVERAGE WEIGHT	MSRP
FIXED-POSITION SKELETONIZED STOCK 12-GAUGE 2¾" AND 3"						
11701	18.5"	Skeletonized	Black synthetic	40"	8.0 lbs.	\$2299

COMMON SPECIFICATIONS: Magazine Capacity: 5+1 Chokes: Fixed M Type of Sights: Ghost-ring Length of Pull: 14¼" Drop at Heel: 2¼" Drop at Comb: 1½" †Receiver drilled and tapped for scope mount. Anti-reflective MILSPEC finish. Synthetic stock. Picatinny rail is included.



The Benelli M1014 features the United States flag engraved on the receiver in honor of this model's use by the U.S. Marine Corps.

Semi-Auto Defense Guns (continued)

M2 and M3 Tactical Models



M2 TACTICAL, PISTOL GRIP – 12-GA, 3"
ITEM # 11052 Black synthetic, Ghost-ring sight



M2 TACTICAL, COMFORTECH® – 12-GA, 3"
ITEM # 11029 Black synthetic, Ghost-ring sight



M3 CONVERTIBLE, PISTOL GRIP – 12-GA, 3"
ITEM # 11606 Black synthetic, Ghost-ring sight

Benelli's M2 Tactical Shotgun has passed the test of time; establishing itself as the shotgun of choice for serious tactical needs. Outfitted with Benelli's Inertia Driven® technology, it utilizes recoil energy to cycle the action and eliminate fouling problems.

The M3 offers the option of choosing either semi-auto or pump-action operation, depending on the intended purpose. It's easy to select fast-cycling semi-auto fire with conventional loads or you can choose pump-action for low-energy special purpose loads.

M2/M3 STANDARD FEATURES

CHOKE TUBES: Crio® IC, M & F on M2- fixed C on M3 Convertible- Standard M on M4.

FINISHES: Black synthetic.

SIGHTS: M2 Tactical in ghost-ring and open rifle. M3 Convertible ghost-ring only.

DRILLED & TAPPED: Standard on M2 ghost-ring.

M2 OPTIONAL FEATURES

GEL RECOIL PADS: Three options to customize length of pull (ComforTech® only).

TRITIUM INSERTS: Three-dot tritium inserts available for ghost-ring sights.

BARRELS: A variety of field and slug barrels available.

M2 TACTICAL

ITEM NUMBER	BARREL LENGTH	STOCK (BLACK SYNTH.)	TYPE OF SIGHTS	OVERALL LENGTH	AVERAGE WEIGHT	MSRP
M2 TACTICAL† 12-GAUGE 2¾" AND 3"						
11052†	18.5"	Pistol Grip	Ghost-ring	39.75"	6.7 lbs.	\$1699
11053†	18.5"	Tactical	Ghost-ring	39.75"	6.7 lbs.	\$1599
11054	18.5"	Pistol Grip	Open Rifle	39.75"	6.7 lbs.	\$1599
11029†	18.5"	ComforTech®	Ghost-ring	39.75"	6.7 lbs.	\$1699

COMMON SPECIFICATIONS: Magazine Capacity: 5+1 Crio® Chokes: IC, M, F Length of Pull: 14¼" Drop at Heel: 2" Drop at Comb: 1¼" Minimum recommended load: 3-dram, 1¼-oz. loads. †Receiver drilled and tapped for 93A Weaver base.

M3 CONVERTIBLE AUTO/PUMP

ITEM NUMBER	BARREL LENGTH	STOCK (BLACK SYNTH.)	TYPE OF SIGHTS	OVERALL LENGTH	AVERAGE WEIGHT	MSRP
M3 CONVERTIBLE 12-GAUGE 2¾" AND 3"						
11606	19.75"	Pistol Grip	Ghost-ring	41"	7.2 lbs.	\$1949

COMMON SPECIFICATIONS: Magazine Capacity: 5+1 Chokes: Fixed Cyl. Length of Pull: 14¼" Drop at Heel: 2" Drop at Comb: 1¼"

SPECIFICATIONS AND PRICES SUBJECT TO CHANGE WITHOUT NOTICE.

Pump-Action Defense Guns

Rock-Solid Repeaters



NOVA PUMP TACTICAL – 12-GA, 3½"
ITEM # 20051 Black synthetic, Ghost-ring sight



NOVA PUMP TACTICAL, H₂O – 12-GA, 3½"
ITEM # 20090 Black synthetic, Open rifle sight



SUPERNOVA TACTICAL, COMFORTECH™ – 12-GA, 3½"
ITEM # 20145 Black synthetic, Open rifle sight



SUPERNOVA TACTICAL, PISTOL GRIP – 12-GA, 3½"
ITEM # 20160 Black synthetic, Ghost-ring sight

SUPERNOVA TACTICAL

ITEM NUMBER	BARREL LENGTH	STOCK (SYNTHETIC)	TYPE OF SIGHTS	OVERALL LENGTH	AVERAGE WEIGHT	MSRP
SUPERNOVA TACTICAL† 12-GAUGE 2¾", 3" AND 3½"						
20145	18"	ComforTech®	Open Rifle	40"	7.6 lbs.	\$579
20155	18"	ComforTech®	Ghost-ring	40"	7.6 lbs.	\$629
20160	18"	Pistol Grip	Ghost-ring	40"	7.6 lbs.	\$629

COMMON SPECIFICATIONS: Magazine Capacity: 4+1 Chokes: Fixed Cyl. Length of Pull: 14¼" Drop at Heel: 2¼" Drop at Comb: 1¼" †Receiver drilled and tapped for scope base.

NOVA TACTICAL

ITEM NUMBER	BARREL LENGTH	STOCK	TYPE OF SIGHTS	OVERALL LENGTH	AVERAGE WEIGHT	MSRP
NOVA PUMP TACTICAL 12-GAUGE 2¾", 3" AND 3½"						
20051	18.5"	Black Synthetic	Ghost-ring	39.75"	7.2 lbs.	\$499
20050	18.5"	Black Synthetic	Open Rifle	39.75"	7.2 lbs.	\$479
NOVA PUMP H₂O 12-GAUGE 2¾", 3" AND 3½"						
20090§	18.5"	Black Synthetic	Open Rifle	39.75"	7.2 lbs.	\$689

COMMON SPECIFICATIONS: Magazine Capacity: 4+1 Chokes: Fixed Cyl. Length of Pull: 14¼" Drop at Heel: 2¼" Drop at Comb: 1¼" §Matte nickel-plated barrel, magazine tube and cap, trigger group and all other inner metal parts.

SUPERNOVA TACTICAL STANDARD FEATURES

CHOKE TUBES: Fixed cylinder.

FINISHES: All models available in Black synthetic. **SHIM KIT:** For adjustment of drop and cast (avail. for SuperNova ComforTech® model only). **SIGHTS:** Ghost-ring or open rifle.

OPTIONAL FEATURES

GEL RECOIL PADS: Three options to customize length of pull (ComforTech® only).

BARRELS: Variety of field barrels.

TRITIUM INSERTS: Three-dot tritium inserts available for ghost-ring sights.

SuperNova Dependable Pump-Action



SUPERNOVA – 12-GA, 3½"
ITEM # 20116 Realtree® Max-7™



Benelli's SuperNova embodies a modular design with a lightweight steel skeletal framework overmolded with a high-tech polymer, making the SuperNova super-light, super-strong and impervious to all weather conditions.



SUPERNOVA – 12-GA, 3½" ITEM # 20105 Black synthetic



MODULAR STOCK SYSTEM

The SuperNova is available with a choice of two modular buttstocks, and can be quickly reconfigured with a 13 mm socket wrench. Both stocks are made of tough synthetic material with textured matte finish to offer years of reliable service.



SUPERNOVA

ITEM NUMBER	BARREL LENGTH	STOCK	OVERALL LENGTH	AVERAGE WEIGHT	MSRP
SUPERNOVA 12-GAUGE 2¾", 3" AND 3½"					
20100	28"	Black synthetic	49.5"	8.0 lbs.	\$629
20105	26"	Black synthetic	47.5"	7.9 lbs.	\$629
20110	24"	Black synthetic	45.5"	7.8 lbs.	\$629
20117	28"	Realtree® Max-7™	49.5"	8.0 lbs.	\$749
20116	26"	Realtree® Max-7™	47.5"	7.9 lbs.	\$749

COMMON SPECIFICATIONS: Magazine Capacity: 4+1 Chokes: IC, M, F (except for rifled slug - rifled bore) Type of Sights: Red-bar front sight (except for rifled slug - Adj. Rifle) Length of Pull: 14¼" Drop at Heel: 2¼" Drop at Comb: 1¼" †Receiver drilled and tapped for scope mounting.

SPECIFICATIONS AND PRICES SUBJECT TO CHANGE WITHOUT NOTICE.

The SuperNova's styled trigger guard delivers 30% more finger room to accommodate a gloved hand, along with a larger safety button for easy access and quick, positive function.



STANDARD FEATURES

CHOKE TUBES: IC, M, F choke tubes and wrench.
FINISHES: Realtree® Max-7™, Black synthetic.
SHIM KIT: For adjustment of drop and cast.

OPTIONAL FEATURES

CHOKE TUBES: Extended chokes for pass shooting (M), shooting waterfowl over decoys (IC) and for turkey hunting (XF) (12-gauge only).
GEL RECOIL PADS: Three options to customize length of pull to 13⅞", 14⅜" and 14⅞".
RAISED COMB PADS: Three options to customize comb height.

Nova Pump

NOVA PUMP – 12-GA, 3½" ITEM # 20011 Mossy Oak® Bottomland™



NOVA PUMP – 12-GA, 3½" ITEM # 20065 Realtree® Max-7™



NOVA PUMP COMPACT – 20-GA, 3" ITEM # 20036 Black synthetic



NOVA PUMP – 20-GA, 3" ITEM # 20042 Mossy Oak® Bottomland™



STANDARD FEATURES

CHOKE TUBES: IC, M, F choke tubes and wrench.
FINISHES: Mossy Oak® Bottomland™, Realtree® Max-7™, Black synthetic.

OPTIONAL FEATURES

CHOKE TUBES: Extended chokes for pass shooting (IM), shooting waterfowl over decoys (IC) and for turkey hunting (XF) (12-gauge only).

NOVA PUMP

ITEM NUMBER	BARREL LENGTH	STOCK	OVERALL LENGTH	AVERAGE WEIGHT	MSRP
NOVA PUMP 12-GAUGE 2¾", 3" AND 3½"					
20000	28"	Black synthetic	49.5"	8.0 lbs.	\$499
20003	26"	Black synthetic	47.5"	7.9 lbs.	\$499
20066	28"	Realtree® Max-7™	49.5"	8.0 lbs.	\$629
20065	26"	Realtree® Max-7™	47.5"	7.9 lbs.	\$629
20011	28"	Mossy Oak® Bottomland™	49.5"	8.0 lbs.	\$629
20010	26"	Mossy Oak® Bottomland™	47.5"	7.9 lbs.	\$629
NOVA PUMP 20-GAUGE 2¾" AND 3"					
20030	26"	Black synthetic	47.5"	6.6 lbs.	\$499
20042	26"	Mossy Oak® Bottomland™	47.5"	6.6 lbs.	\$629
20043	24"	Mossy Oak® Bottomland™	45.5"	6.5 lbs.	\$629
NOVA PUMP COMPACT 20-GAUGE 2¾" AND 3"					
20036	24"	Black synthetic	44.2"	6.4 lbs.	\$499

COMMON SPECIFICATIONS: Magazine Capacity: 4+1 Chokes: IC, M, F Type of Sights: Red-bar front sight Length of Pull: 14¼" (compact 13") Drop at Heel: 2¼" (compact 2") Drop at Comb: 1¼"

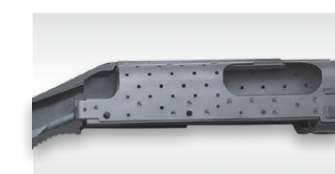

The Nova is truly a 21st century pump-action shotgun. Corrosion-proof polymer is overmolded on a skeleton framework to form the one-piece receiver and buttstock in a revolutionary shotgun-manufacturing process.

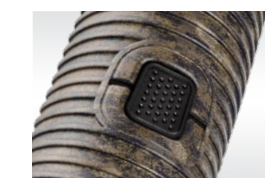

The button on the underside of the forend activates a shell stop, allowing a chambered shell to be removed without releasing rounds from the magazine.



Ergonomic grooves on the Nova pistol grip provide a positive gripping surface and distinctive look on Benelli's original pump gun.

828 U

A shotgun built on imagination, not on past inspiration.



The first O/U inspired by innovation that breaks the traditional mold.

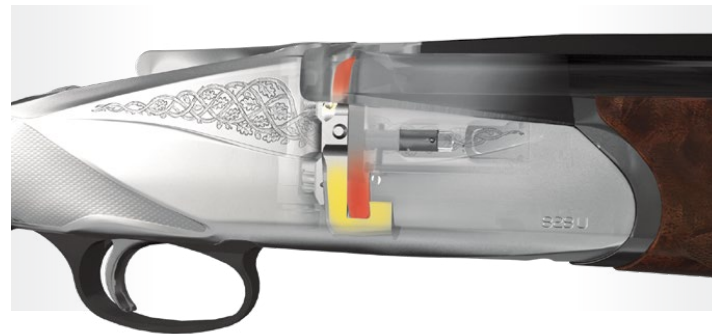

Steel locking system

Benelli's patented steel locking system eliminates wear and tear on the receiver and hinge that can cause traditional O/U's to fail. By incorporating this locking system into an aluminum receiver, we created a stronger, safer, lighter O/U that's perfectly balanced and weighs only 6.5 pounds.



Opening lever

The 828U strikers reset when the top lever is unlocked, instead of when the barrels open as in traditional O/U's. This creates a smoother, more consistent opening action. Left-hand models are now available, which include a left-handed opening lever.



Steel locking plate

The heart of Benelli's Steel Locking System is a solid steel breech block that locks directly to the rear of the barrel. This contains all pressure from the shotshell inside and prevents its transfer to the receiver and hinge pins.



Impulse-activated ejectors

The ejector system in the 828U is entirely contained on the barrel. Pressure activates the ejector when the shell is fired. This innovative design eliminates need for linkages between the trigger group and the forend, resulting in a stronger, more streamlined ejector system.



Adjustable drop and cast

Benelli has created the first O/U that allows for a custom-fit stock. With five drop and four cast shims, the 828U can be adjusted to one of 40 possible stock positions. The adjustable stock allows shooters to find natural alignment with the barrel and target, which results in superior accuracy.



Removable trigger group

The compact and removable trigger group makes for easier cleaning and eliminates complicated linkage between the forearm and trigger mechanism, significantly increasing reliability.



PROGRESSIVE COMFORT

Progressive Comfort and the 828U

The Progressive Comfort System is housed within the 828U's walnut stock. The progressive nature of the system allows for consistently smooth levels of recoil absorption with all shotshell loads, light or heavy.

Stage 1 of recoil

When a light load is fired, the first set of buffers (shown in yellow) engages and compresses to absorb recoil energy.



Stage 2 of recoil

When firing more powerful shells (heavy field loads), the second set of buffers (shown in orange) engages after the first set has compressed to absorb more recoil.



Stage 3 of recoil

The third and most rigid set of buffers (shown in red) comes into play when a magnum load is fired, providing a final layer of cushioning from recoil produced by the heaviest shotshell loads.



828U

Ultimate Integration of Design, Comfort and Technology



828U – 20-GA, 3"
ITEM # 10741 AA-Grade satin walnut



828U



828U – 12-GA, 3"
ITEM # 10702 AA-Grade satin walnut

828U

ITEM NUMBER	BARREL LENGTH	STOCK	OVERALL LENGTH	AVERAGE WEIGHT	MSRP
20-GAUGE 2¾" & 3" – ENGRAVED NICKEL-PLATED RECEIVER					
10740	26"	AA-Grade satin walnut	43.25"	5.9 lbs.	\$3699
10741	28"	AA-Grade satin walnut	45.25"	6.0 lbs.	\$3699

COMMON SPECIFICATIONS: Crio® Chokes: C,IC,M,IM,F Type of Sights: Fiber-optic front sight with red insert Length of Pull: 14¾" Drop at Heel: 2½" Drop at Comb: 1½"

A shotgun that feels and shoots like a Benelli from the moment you pick it up to the moment your target falls.

Innovation and inspiration combined to create the 828U – the first O/U worthy of the Benelli badge. With the strength of steel and the light weight of aluminum, the 12-gauge 828U redefined the upland game shotgun category. Now also available in 20-gauge.

The 828U features a patented steel locking system and plate, which eliminates the transference of stress-causing shot pressure to the receiver and hinge pins. A compact, easily removable trigger group increases safety, reliability and ease of cleaning. The unique opening lever provides a smoother, more consistent opening action. From butt to muzzle, there is nothing conventional about the Benelli 828U.

STANDARD FEATURES

CHOKE TUBES: C, IC, M, IM, F Crio® choke tubes and wrench.

FINISH: AA-Grade satin walnut.

RECEIVER: Engraved nickel-plated.

SHIM KIT: Forty points of fine adjustment of drop and cast for custom fit.

HARD CASE: Custom-fitted hard case to protect during transport.

OPTIONAL FEATURES

CHOKE TUBES: Extended chrome Crio® choke tubes C, IC, M, IM, F.

828U					
ITEM NUMBER	BARREL LENGTH	STOCK	OVERALL LENGTH	AVERAGE WEIGHT	MSRP
12-GAUGE 2¾" & 3" – BLACK ANODIZED RECEIVER					
10701	26"	AA-Grade satin walnut	43.25"	6.5 lbs.	\$3099
10702	28"	AA-Grade satin walnut	45.25"	6.6 lbs.	\$3099
10705	30"	AA-Grade satin walnut	47.25"	6.7 lbs.	\$3099
12-GAUGE 2¾" & 3" – ENGRAVED NICKEL-PLATED RECEIVER					
10703	26"	AA-Grade satin walnut	43.25"	6.5 lbs.	\$3699
10704	28"	AA-Grade satin walnut	45.25"	6.6 lbs.	\$3699
10706	30"	AA-Grade satin walnut	47.25"	6.7 lbs.	\$3699
LEFT-HAND 12-GAUGE 2¾" & 3" – ENGRAVED NICKEL-PLATED RECEIVER					
10707	26"	AA-Grade satin walnut	43.25"	6.5 lbs.	\$3399
10708	28"	AA-Grade satin walnut	45.25"	6.6 lbs.	\$3399
COMPACT 12-GAUGE 2¾" & 3" – ENGRAVED NICKEL-PLATED RECEIVER					
10709	26"	AA-Grade satin walnut	42"	6.5 lbs.	\$3399

COMMON SPECIFICATIONS: Crio® Chokes: C,IC,M,IM,F Type of Sights: Fiber-optic front sight with red insert Length of Pull: 14¾" (Compact: 13½") Drop at Heel: 2½" Drop at Comb: 1½"

STANDARD FEATURES

CHOKE TUBES: C, IC, M, IM, F Crio® choke tubes and wrench.

FINISH: AA-Grade satin walnut.

RECEIVER: Engraved nickel-plated or anodized.

SHIM KIT: Forty points of fine adjustment of drop and cast for custom fit.

HARD CASE: Custom-fitted hard case to protect during transport.

OPTIONAL FEATURES

CHOKE TUBES: Extended chrome Crio® choke tubes C, IC, M, IM, F.



828U Sport

A Leader in Performance and Innovation



828U SPORT – 12-GA, 3"
ITEM #10730 Matte blued steel,
AA-Grade Satin walnut

Benelli delivers innovative performance advantages in its 828U Sport. A patented steel locking system reduces wear on the receiver and hinge, a point where lesser break-action guns fail. Integrated adjustment capability helps you tailor the balance point for optimal performance. Tune the trigger position to your finger length. A sight channel in the wide rib over anti-glare barrels aids fast target alignment with the white bead sight. Cryogenic barrel and choke treatment results in consistent patterns and more pellets on target. These enhancements and more make the 828U Sport a standout among sporting over/under shotguns.



828U



The 828U Sport's trigger can be moved forward or backwards so your finger sits exactly where you want. Customize it to your finger length.



A patented steel locking system delivers consistently reliable lock-ups while eliminating wear and tear on the receiver hinges - a vulnerability in shotguns costing far more.



Each 828U Sport comes with five extended nickel/colored chokes, drop and cast shims for a custom fit, balance weights, a manual, a trigger tool, a choke wrench and oil.



Progressive Balancing

A balanced shotgun is essential for consistent performance. Our engineers created an innovative adjustable balance system using small weights in the buttstock. Add or remove them to move the gun's center of balance fore or aft.



828U SPORT

ITEM NUMBER	BARREL LENGTH	STOCK	OVERALL LENGTH	AVERAGE WEIGHT	MSRP
12-GAUGE 2 3/4" & 3"					
10730	30"	AA-Grade satin walnut	47.25"	8.05 lbs.	\$4799
10731	32"	AA-Grade satin walnut	49.25"	8.15 lbs.	\$4799

COMMON SPECIFICATIONS: Extended Crio® Chokes: C, IC, M, IM, F Type of Sights: White bead front sight Length of Pull: 14 1/4" Drop at Heel: 2 1/4" Drop at Comb: 1 1/2" Automatic Ejectors

SPECIFICATIONS AND PRICES SUBJECT TO CHANGE WITHOUT NOTICE.

STANDARD FEATURES

EXTENDED CHOKE TUBES: C, IC, M, IM, F Crio® choke tubes and wrench.
FINISH: AA-Grade satin walnut.

RECEIVER: Matte blued steel with "SPORT" engraved.

SHIM KIT: Forty points of fine adjustment of drop and cast for custom fit.

HARD CASE: Custom-fitted hard case to protect during transport.

ADJUSTABLE TRIGGER POSITION

OPTIONAL FEATURES

CHOKE TUBES: Flush chrome Crio® choke tubes C, IC, M, IM, F.

828U Steel Field

Smooth-Shooting Excellence Defined

NEW!



828U STEEL FIELD – 12-GA, 3"
ITEM #10751 Brushed gray/gloss blue, AA-Grade Satin walnut

 **PROGRESSIVE COMFORT**

 **LOCK PLATE**

 **PERFECT FIT**

828U

This new version of our already superb 828U is outfitted with a sleek steel receiver that adds just enough weight to help mitigate the recoil of heavier upland loads and deliver a smooth, even swing on fast crossing shots. The handsome brushed gray receiver and gloss-finished barrels provide an elegant look in the field or on the clays range and the Progressive Comfort System contained within the striking AA-Grade walnut stock makes shooting the 828U a joy. Our patented, rock-solid steel locking system, top lever trigger reset and an ejector system contained entirely inside the barrels round out the innovations on this outstanding firearm. The 12-gauge is available with 26-, 28- or 30-inch barrels and the 20-gauge is available with 26- or 28-inch barrels.

828U STEEL FIELD

ITEM NUMBER	BARREL LENGTH	STOCK	OVERALL LENGTH	AVERAGE WEIGHT	MSRP
12-GAUGE 2 3/4" & 3" – BRUSHED GRAY STEEL RECEIVER					
10750	26"	AA-Grade satin walnut	43.25"	7.6 lbs.	\$3699
10751	28"	AA-Grade satin walnut	45.25"	7.7 lbs.	\$3699
10752	30"	AA-Grade satin walnut	47.25"	7.8 lbs.	\$3699
20-GAUGE 2 3/4" & 3" – BRUSHED GRAY STEEL RECEIVER					
10755	26"	AA-Grade satin walnut	43.25"	6.9 lbs.	\$3699
10756	28"	AA-Grade satin walnut	45.25"	7.0 lbs.	\$3699

COMMON SPECIFICATIONS: Crio® Chokes: C, IC, M, IM, F Type of Sights: Fiber-optic front sight with red insert Length of Pull: 14 3/4" Drop at Heel: 2 1/2" Drop at Comb: 1 1/2" Shell Ejectors



828U STEEL FIELD – 20-GA, 3"
ITEM #10756 Brushed gray/gloss blue, AA-Grade Satin walnut

STANDARD FEATURES

CHOKE TUBES: C, IC, M, IM, F Crio® choke tubes and wrench.
FINISH: AA-Grade satin walnut.
STEEL RECEIVER: Brushed gray, gold inlaid engraving.
SHIM KIT: Forty points of fine adjustment of drop and cast for custom fit.
HARD CASE: Custom-fitted hard case to protect during transport.

OPTIONAL FEATURES

CHOKE TUBES: Extended chrome Crio® choke tubes C, IC, M, IM, F.

Benelli's patented steel locking system eliminates wear and tear on the receiver and hinge that can cause traditional O/U's to fail. By incorporating this locking system into our steel receiver, we have created a stronger, safer O/U that's smooth swinging and perfectly balanced.



Performance Shop

Optimized For Quick-Shooting Accuracy



828U UPLAND – 12-GA, 3"
ITEM #10700 Anodized bronze/matte blue, AA-Grade Satin walnut

 **PROGRESSIVE COMFORT**

 **LOCK PLATE**

 **PERFECT FIT**

828U



Enjoy the benefits of a superb 828U over/under optimized for fast handling and accuracy. The slightly shorter length of pull and 24-inch barrels promote control and speed. Lengthened forcing cones team with included Triple Threat® chokes to produce tighter patterns over longer ranges. With the 12-gauge weighing in at less than 6.5 lbs. and the 20-gauge tipping the scales at just 5.8 lbs., these guns are a joy to carry all day. Shells are partially extracted, not ejected, for complete control of loading and unloading. Carbon-fiber stepped rib with easy-to-see fiber-optic front sight. Tang-mounted automatic safety with barrel selector can be made into a manual safety. Included shims facilitate dozens of adjustments for a custom fit. Comes with a total of eight chokes.

PERFORMANCE SHOP – 828U UPLAND

ITEM NUMBER	BARREL LENGTH	STOCK	OVERALL LENGTH	AVERAGE WEIGHT	MSRP
12-GAUGE 2 3/4" & 3" – BRONZE ANODIZED RECEIVER					
10700	24"	AA-Grade satin walnut	41.25"	6.4 lbs.	\$3999
20-GAUGE 2 3/4" & 3" – BRONZE ANODIZED RECEIVER					
10712	24"	AA-Grade satin walnut	41.25"	5.8 lbs.	\$3999

COMMON SPECIFICATIONS: Crio® Chokes: C, IC, M, IM, F Type of Sights: Fiber-optic front sight with red insert Length of Pull: 14 3/4" Drop at Heel: 2 1/2" Drop at Comb: 1 1/2" Shell Extractors



The compact and removable trigger group makes for easier cleaning and eliminates complicated linkage between the forearm and trigger mechanism, significantly increasing reliability.



Benelli's patented steel locking system eliminates wear and tear on the receiver and hinge that can cause traditional O/U's to fail. By incorporating this locking system into an aluminum receiver, we created a stronger, safer, lighter O/U that's perfectly balanced and weighs only 6.4 pounds.



The 828U Performance Shop Upland includes five flush choke tubes plus the Triple Threat® Series Choke System, which consists of the T1 (close-range), T2 (mid-range) and T3 (long-range) extended chokes.

Performance Shop ETHOS Supersport AI

NEW!



INERTIA DRIVEN SYSTEM
ETHOS SUPERSPORT AI – 12-GA, 3"
ITEM #12616 Carbon-fiber finish



PERFORMANCE SHOP – ETHOS SUPERSPORT

ITEM NUMBER	BARREL LENGTH	STOCK	OVERALL LENGTH	AVERAGE WEIGHT	MSRP
ETHOS SUPERSPORT – 12-GAUGE 2¾" AND 3"					
12616	30"	Carbon-fiber finish	51.5"	7.0 lbs.	\$3399

COMMON SPECIFICATIONS: Barrel: Advanced Impact Crio® barrel Bolt: Briley® EZ bolt release and enlarged bolt-operating handle Recoil Reduction: Benelli Comfort Tech® 3 System with Briley® 6-oz. weighted forend cap Magazine Capacity: 4+1 Advanced Impact Extended Crio® Chokes: C, IC, M, IM, F Briley Spectrum A.I. Extended Chokes: SK, IC Type of Sights: Fiber-optic front sight with red insert and metal bead mid-sight Length of Pull: 14½" Drop at Heel: 2¼" Drop at Comb: 1½" Minimum recommended load: ¾-oz. loads.

SPECIFICATIONS AND PRICES SUBJECT TO CHANGE WITHOUT NOTICE.

The Performance Shop ETHOS SuperSport guns feature: A.) a Briley EZ. bolt release and ergonomic bolt-operating handle; B.) a custom 6-ounce weighted forend cap for great forward balance; and C.) Advanced Impact extended, Crio choke tubes.

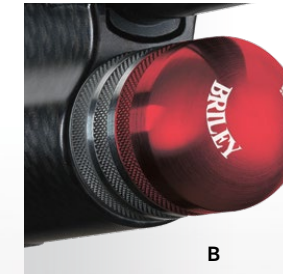

The ETHOS Supersport A.I. is the first competition shotgun from the Benelli Performance Shop to feature the all-new A.I. (Advanced Impact) barrel system and A.I. Crio® choke tubes. Offered in 3-in. 12-ga., the ETHOS Supersport A.I. cuts a fine figure on the range with its carbon-fiber finish, Comfort Tech® 3 recoil reduction system, nickel-plated receiver, and red anodized Briley bolt handle, bolt release, and weighted forend cap.



BENELLI ADVANCED IMPACT

Benelli Advanced Impact – It's all about improvement in ENERGY and VELOCITY, significantly improving both, the further the shot travels away from the muzzle, when compared to existing barrel technology.

ADVANCED IMPACT BALLISTICS

DISTANCE (METERS)	EXTRA VELOCITY	EXTRA ENERGY
1	4%	6%
10	9%	14%
20	15%	24%
30	21%	36%
40	28%	49%
50	35%	63%
60	42%	77%

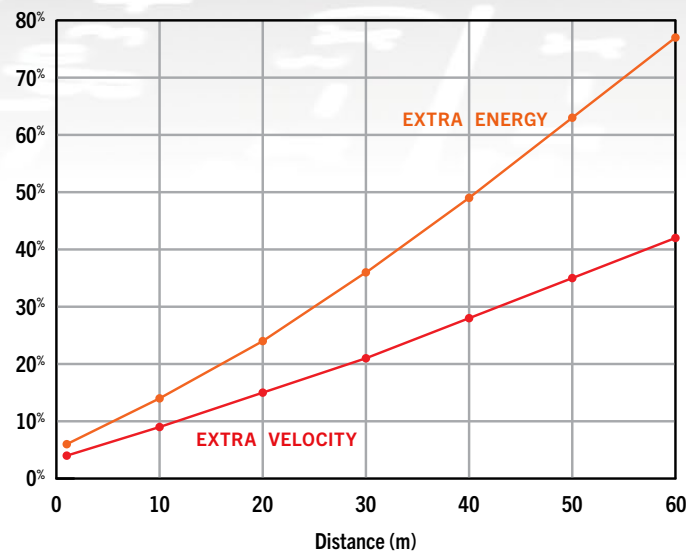

In its simplest form, Advanced Impact technology is revolutionary new ballistic contours within the barrel's bore. It is a system, consisting of the new bore contours and new Advanced Impact CRIO Chokes.

Benefits of Benelli's Advanced Impact technology:

Improved Penetration
– Testing reveals ~50% deeper penetration

Improved Pellet Density
– Testing shows a more uniform and cylindrical shot string

All that adds up to *greatly improved stopping power* compared to other existing barrel technology.

Standard Barrel

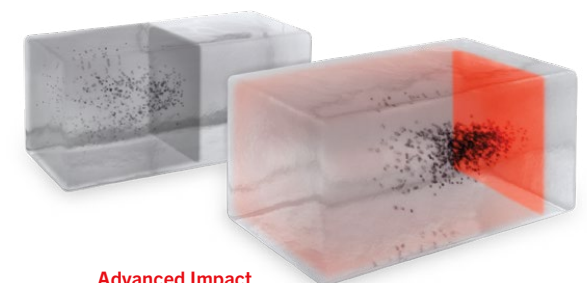

Advanced Impact

Performance Shop Ethos Sport A.I.

NEW!



ETHOS SPORT A.I. – 12-GA, 3"
ITEM # 12601 AA-Grade satin walnut



Benelli's new Advanced Impact (A.I.) barrel technology and ETHOS series competition performance meets classical styling with the Performance Shop ETHOS Sport A.I. Offered in a 3-in. 12-ga. chamber and 30-in. barrel length, the ETHOS Sport A.I. boasts an exquisite AA-grade satin walnut forend and Progressive Comfort recoil reducing stock. Upgraded with a Briley EZ bolt release, ergonomic bolt handle, and a 6-oz. weighted forend cap to enhance forward balance, this shotgun sets new aesthetic and performance standards for the competition world.

ETHOS SPORT A.I.

ITEM NUMBER	BARREL LENGTH	STOCK	OVERALL LENGTH	AVERAGE WEIGHT	MSRP
ETHOS 12-GAUGE 2¾" AND 3" – NICKEL-PLATED RECEIVER					
12601	30"	AA-Grade satin walnut	51.5"	6.8 lbs.	\$3399

COMMON SPECIFICATIONS: Magazine Capacity: 4+1 Advanced Impact Extended Crio® Chokes: C,IC,M,IM,F Briley Spectrum A.I. Extended Chokes: SK,IC Type of Sights: Fiber-optic front sight with red insert and metal bead mid-sight Length of Pull: 14¼" Drop at Heel: 2¼" Drop at Comb: 1½" Minimum recommended load: ¾-oz. loads.

STANDARD FEATURES

- EXTENDED CHOKE TUBES:** Advanced Impact C, IC, M, IM, F Crio® chokes and Briley Spectrum Advanced Impact SK, IC chokes.
- FINISH:** AA-Grade satin walnut.
- RECEIVER:** Nickel-plated.
- ADVANCED IMPACT BARREL:** Gloss
- SHIM KIT:** For adjustment of drop and cast.
- HARD CASE:** Custom-fitted hard case to protect during transport.
- SPECIFICATIONS AND PRICES SUBJECT TO CHANGE WITHOUT NOTICE.



Red anodized accents courtesy of Briley bolt controls and a 6-ounce weighted forend cap add form to function, ideally complimenting the Performance Shop ETHOS Sport A.I.'s classic wood-and-steel presentation. A.I. Crio® extended choke tubes in C, IC, M, IM, and F are included.

Performance Shop Ethos Cordoba A.I. BE.S.T.

NEW!



ETHOS CORDOBA A.I. BE.S.T. – 12-GA, 3"
ITEM # 10641 Black synthetic



Developed for those who demand the most out of their firearms, the Performance Shop ETHOS Cordoba A.I. BE.S.T. blends the fine balance and reliable performance of the Performance Shop ETHOS Sport A.I. and ETHOS Supersport A.I. competition models with a rugged stock and finish that is ready to take on any adventure...in any weather. With its performance-enhanced Advanced Impact (A.I.) barrel profile and A.I. Crio choke system boosting velocity and energy as the shot moves away from the muzzle—all while offering denser and more uniform pellet distribution downrange—the Performance Shop ETHOS Cordoba A.I. BE.S.T. is a gamechanger. What's more, the sleek, black synthetic furniture and Benelli's BE.S.T. metal finish ensures this shotgun will withstand the harshest conditions.

PERFORMANCE SHOP ETHOS CORDOBA A.I.

ITEM NUMBER	BARREL LENGTH	STOCK	OVERALL LENGTH	AVERAGE WEIGHT	MSRP
ETHOS CORDOBA BE.S.T. – 12-GAUGE 2¾" AND 3"					
12631	28"	Black synthetic	49.5"	6.9 lbs.	\$3649

COMMON SPECIFICATIONS: Magazine Capacity: 4+1 Advanced Impact Extended Crio® Chokes: C,IC,M,IM,F Briley Spectrum A.I. Extended Chokes: SK,IC Type of Sights: Fiber-optic front sight with red insert and metal bead mid-sight Length of Pull: 14¼" Drop at Heel: 2¼" Drop at Comb: 1½" Minimum recommended load: ¾-oz. loads.

STANDARD FEATURES

- EXTENDED CHOKE TUBES:** Advanced Impact C, IC, M, IM, F Crio® chokes and Briley Spectrum Advanced Impact SK, IC chokes..
- FINISH:** Black synthetic.
- RECEIVER:** Anodized.
- ADVANCED IMPACT BARREL:** Matte BE.S.T.-treated
- SHIM KIT:** For adjustment of drop and cast.
- SHELL VIEW**
- HARD CASE:** Custom-fitted hard case to protect during transport.
- SPECIFICATIONS AND PRICES SUBJECT TO CHANGE WITHOUT NOTICE.



Able to cycle a broad range of loads courtesy of Benelli's Inertia Driven System, the Performance Shop ETHOS Cordoba A.I. BE.S.T. has everything demanded by discerning shooters: a rust-, corrosion-, and abrasion-resistant finish, an ergonomic and recoil-reducing stock, comfortable cheek pad, over-sized controls, weighted mag cap, and a high-visibility fiber-optic front sight.

Performance Shop Unrivaled Upland Shotgun



ETHOS UPLAND – 12-GA, 3"
ITEM #11461 AA-Grade satin walnut



PERFORMANCE SHOP – ETHOS UPLAND

ITEM NUMBER	BARREL LENGTH	STOCK	OVERALL LENGTH	AVERAGE WEIGHT	MSRP
ETHOS UPLAND 12-GAUGE 2¾" AND 3"					
11461	26"	AA-Grade satin walnut	47.5"	6.6 lbs.	\$3299
ETHOS UPLAND 20-GAUGE 2¾" AND 3"					
11471	26"	AA-Grade satin walnut	47.5"	5.6 lbs.	\$3299

COMMON SPECIFICATIONS: Barrel: Lengthened forcing cone, EDM Ported Crio Barrel[®] Magazine Capacity: 4+1 Crio[®] Chokes: C, IC, M, IM, F Extended Chokes: Three Rob Roberts Custom Triple Threat[®] Type of Sights: Interchangeable fiber-optic front sight with red, green and yellow inserts Length of Pull: 14¼" Drop at Heel: 2¼" Drop at Comb: 1¼" Minimum recommended load: 3-dram, ¼-oz. loads (12-ga.). 2¼-dram, ¼-oz. loads (20-ga.).



An enlarged bolt handle and bolt-release lever improve ease of operation, even with gloved hands.



A carbon-fiber rib and EDM barrel porting come standard on the new Performance Shop ETHOS Upland shotgun.



The Performance Shop ETHOS includes five flush choke tubes plus the Triple Threat[®] Series Choke System which consists of the T1 (close-range), T2 (mid-range) and T3 (long-range) extended chokes.

Performance Shop High Performance, Hard Working



M2 3-GUN EDITION – 12-GA, 3"
ITEM #11022 Black synthetic



PERFORMANCE SHOP – M2 3-GUN EDITION

ITEM NUMBER	BARREL LENGTH	STOCK	OVERALL LENGTH	AVERAGE WEIGHT	MSRP
M2 12-GAUGE 2¾" AND 3"					
11022	24"	Black synthetic	45.5"	6.75 lbs.	\$2599

COMMON SPECIFICATIONS: Magazine Capacity: 3+1 Crio[®] Chokes: C, IC, M, IM, F Type of Sights: HIVIZ Comp front sight, XS Sight Systems Express Sight Length of Pull: 14¼" Drop at Heel: 2" Drop at Comb: 1¼" Minimum recommended load: 3-dram, 1¼-oz. loads (12-ga.). Nordic bolt handle. RCI-XRAIL port caddy and bolt release button. RCI-XRAIL loading port modifications and TTI Custom carrier to increase speed of reloading.



Operation of this fine-tuned M2 is enhanced by incorporating custom parts from Nordic Components and RCI-XRAIL. The upgrades include a Nordic extended tactical-style bolt handle, and an oversized bolt release and port caddy from RCI-XRAIL.



The loading port has been modified to accommodate quad-loading, and a custom carrier from TTI has been installed to assist with the speed and ease of loading the magazine.

Multi-gun and tactical shotgun competitions push firearms to their limits by demanding the highest levels of reliability and accuracy. Benelli's popular Performance Shop M2 3-Gun shotgun sports a large loading port for greater efficiency when quad loading, an XS express rear sight for slug accuracy, and a port caddy for a spare shell. Benelli's M2 has a stellar reputation as the shotgun of choice for serious 3-gun competitors. Available in 12-gauge only, accepts shells to 3 inches.

SPECIFICATIONS AND PRICES SUBJECT TO CHANGE WITHOUT NOTICE.

Performance Shop Ultimate Gobbler Guns



(Includes Burris® Fast-Fire II™ Red-Dot Reflex Sight)

SBE 3 TURKEY EDITION – 12-GA, 3½"
ITEM #11352 Mossy Oak® Bottomland™

M2 TURKEY EDITION – 20-GA, 3"
ITEM #11197 Mossy Oak® Bottomland™

The Benelli Performance Shop Turkey Edition shotguns are the ultimate turkey guns with Performance Shop enhancements by Rob Roberts, world-renowned for shot pattern development. A Burris® FastFire II™ sight is fitted to each gun, which is then pattern tested with Federal Premium Ammunition. Computer printouts are provided to show actual points of impact in 10-, 20-, and 30-inch circles. Choose the Performance Shop Turkey Edition in either the SBE 3 12-gauge or the lightweight M2 20-gauge model.

PERFORMANCE SHOP – SBE 3 TURKEY

ITEM NUMBER	BARREL LENGTH	STOCK	OVERALL LENGTH	AVERAGE WEIGHT	MSRP
SUPER BLACK EAGLE 3 12-GAUGE 2¾", 3" AND 3½" †					
11352	24"	Bottomland™	46"	6.8 lbs.	\$3399

PERFORMANCE SHOP – M2 TURKEY

ITEM NUMBER	BARREL LENGTH	STOCK	OVERALL LENGTH	AVERAGE WEIGHT	MSRP
M2 20-GAUGE 2¾", AND 3" †					
11197	24"	Bottomland™	45.3"	5.7 lbs.	\$2,949

COMMON SPECIFICATIONS: **Barrel:** EDM Ported Crio Barrel[®] **Magazine Capacity:** 3+1 **Chokes:** Custom XFT Extended Choke and five Benelli (C, IC, M, IM, F) **Type of Sights:** Burris® FastFire™ **Length of Pull:** 14¾" **Drop at Heel:** 2¼" **Drop at Comb:** 1¼" **Minimum recommended load:** 3-dram, 1¼-oz. loads (12-ga.). **Stock:** SteadyGrip™
†Receiver is drilled and tapped for 93A Weaver base.

COMMON SPECIFICATIONS: **Barrel:** EDM Ported Crio Barrel[®] **Magazine Capacity:** 3+1 **Chokes:** Custom XFT Extended Choke and five Benelli (C, IC, M, IM, F) **Type of Sights:** Burris® FastFire™ **Length of Pull:** 14¾" **Drop at Heel:** 2¼" **Drop at Comb:** 1¼" **Minimum recommended load:** 2½-dram, ¾-oz. loads (20-ga.). **Stock:** ComforTech™ stock.
†Receiver is drilled and tapped for 93A Weaver base.



Each Benelli Crio® barrel produces the ultimate and most effective turkey-killing pattern after Roberts lengthens the forcing cone, ports the muzzle, and fits his X-FT extended choke tube.

Performance Shop Dominate the Flyway



(Includes a paracord design survival sling)

SBE 3 WATERFOWL EDITION – 12-GA, 3½"
ITEM # 11355 Matte Labrador Gray BE.S.T./Anodized, GORE™ OPTIFADE™ Waterfowl Timber

SBE 3 WATERFOWL EDITION – 20-GA, 3"
ITEM # 11356 Matte Labrador Gray BE.S.T./Anodized, GORE™ OPTIFADE™ Waterfowl Timber

SBE 3 WATERFOWL EDITION – 28-GA, 3"
ITEM # 11357 Matte Labrador Gray BE.S.T./Anodized, GORE™ OPTIFADE™ Waterfowl Timber

Benelli's Performance Shop faced a formidable challenge when we asked it to customize our already legendary SBE 3 semi-automatic shotgun for serious waterfowlers. They began by crafting an oversized bolt handle and enlarged bolt release to accommodate hunters wearing gloves. A HIVIZ® CompSight® was added for a better sight picture in low light. The forcing cone was lengthened and polished, and three Rob Roberts RRaptor® choke tubes were provided to ensure superior patterns. In fact, SBE3 Waterfowl Edition models are test-fired with a computerized pattern analysis machine to verify consistent and even patterns. 12-, 20- and 28-ga. models are available.

PERFORMANCE SHOP – SBE 3 WATERFOWL

ITEM NUMBER	BARREL LENGTH	FINISH	OVERALL LENGTH	AVERAGE WEIGHT	MSRP
SBE 3 LABRADOR GRAY BE.S.T. – 12-GAUGE 2¾", 3" AND 3½" †					
11355	28"	OPTIFADE™ Timber/Anodized Receiver	50"	7.0 lbs.	\$3649

PERFORMANCE SHOP – SBE 3 WATERFOWL

ITEM NUMBER	BARREL LENGTH	FINISH	OVERALL LENGTH	AVERAGE WEIGHT	MSRP
SBE 3 LABRADOR GRAY BE.S.T. – 20-GAUGE 2¾" AND 3"					
11356	28"	OPTIFADE™ Timber/Anodized Receiver	49.3"	5.9 lbs.	\$3399

PERFORMANCE SHOP – SBE 3 WATERFOWL

ITEM NUMBER	BARREL LENGTH	FINISH	OVERALL LENGTH	AVERAGE WEIGHT	MSRP
SBE 3 LABRADOR GRAY BE.S.T. – 28-GAUGE 2¾" AND 3"					
11357	28"	OPTIFADE™ Timber/Anodized Receiver	49.5"	5.6 lbs.	\$3399

COMMON SPECIFICATIONS: **Barrel:** Lengthened forcing cone **Magazine Capacity:** 3+1 **Chokes:** Three Rob Roberts Custom RRaptor® - RR1, RR2, RR3 **Type of Sights:** HIVIZ® CompSight® **Length of Pull:** 14¾" **Drop at Heel:** 2¼" **Drop at Comb:** 1¼" **Minimum recommended load:** 3-dram, 1¼-oz. loads (12-ga.). **Stock:** ComforTech® 3. †Receiver drilled and tapped for 93A Weaver base.

COMMON SPECIFICATIONS: **Magazine Capacity:** 3+1 **Chokes:** Three Rob Roberts Custom RRaptor® - RR1, RR2, RR3 **Type of Sights:** HIVIZ® CompSight® **Length of Pull:** 14¾" **Drop at Heel:** 2¼" **Drop at Comb:** 1¼" **Minimum recommended load:** 2½-dram, ¾-oz. loads (20-ga.).

COMMON SPECIFICATIONS: **Magazine Capacity:** 2+1 **Chokes:** Three Rob Roberts Custom RRaptor® - RR1, RR2, RR3 **Type of Sights:** HIVIZ® CompSight® **Length of Pull:** 14¾" **Drop at Heel:** 2¼" **Drop at Comb:** 1¼" **Minimum recommended load:** ¾-oz. loads (28-ga.).



A large bolt-cocking handle and a longer, wider bolt-release lever make the Waterfowl Edition shotguns easier to manipulate even when wearing bulky, cold-weather gloves.

SPECIFICATIONS AND PRICES SUBJECT TO CHANGE WITHOUT NOTICE.

Turkey Guns

Specifically Designed Turkey Guns



SUPER BLACK EAGLE 3 STEADYGRIP™ – 12-GA, 3½"
ITEM # 10352 Mossy Oak® Bottomland™



M2 PERFORMANCE SHOP TURKEY EDITION – 20-GA, 3"
ITEM #11197 Mossy Oak® Bottomland™



SBE 3 PERFORMANCE SHOP TURKEY EDITION – 12-GA, 3½"
ITEM #11352 Mossy Oak® Bottomland™



NOVA PUMP – 20-GA, 3"
ITEM #20042 Mossy Oak® Bottomland™



NOVA PUMP COMPACT – 20-GA, 3"
ITEM #20036 Black synthetic

Benelli's turkey shotguns are packed with features serious turkey hunters desire. From gobbler-dropping accuracy and power to recoil-dampening ComforTech® stock technology and the rock-solid grip afforded by SteadyGrip™ stocks, our turkey shotguns consistently deliver reliable performance you can count on in any weather.

TURKEY GUNS with SteadyGrip™

ITEM NUMBER	BARREL LENGTH	STOCK	OVERALL LENGTH	AVERAGE WEIGHT	MSRP
PERFORMANCE SHOP SBE 3 TURKEY† 12-GAUGE 2¾", 3" AND 3½"					
11352	24"	Bottomland™	46"	6.8 lbs.	\$3399
SUPER BLACK EAGLE 3† 12-GAUGE 2¾", 3" AND 3½"					
10352	24"	Bottomland™	46"	6.8 lbs.	\$2349

COMMON SPECIFICATIONS: Magazine Capacity: 3+1 Crio® Flush Chokes: C,IM,F Crio® Extended Chokes: IC,M (SBE3 Perf. Shop Turkey also includes a Rob Roberts XFT extended choke) Type of Sights: Red-bar front sight Length of Pull: 14¼" Drop at Heel: 2¼" Drop at Comb: 1¼" Minimum recommended load: 3-dram, 1¼-oz. loads (12-ga.) †Receiver drilled and tapped for 93A Weaver base.

TURKEY GUNS

ITEM NUMBER	BARREL LENGTH	STOCK	OVERALL LENGTH	AVERAGE WEIGHT	MSRP
SUPER BLACK EAGLE 3† 12-GAUGE 2¾", 3" AND 3½"					
10350	26"	Bottomland™	48"	6.9 lbs.	\$2299
PERFORMANCE SHOP M2 TURKEY 20-GAUGE 2¾" AND 3"					
11197	24"	Bottomland™	45.3"	6.2 lbs.	\$2949
M2 FIELD 12-GAUGE 2¾" AND 3"					
11160	24"	Black synthetic	45.5"	6.6 lbs.	\$1499
11168	26"	Bottomland™	47.5"	6.7 lbs.	\$1599
M2 FIELD 20-GAUGE 2¾" AND 3"					
11184	24"	Black synthetic	45.5"	5.8 lbs.	\$1499
11175	26"	Bottomland™	47.5"	5.9 lbs.	\$1599

COMMON SPECIFICATIONS: Magazine Capacity: 3+1 Crio® Chokes: C,IC,M,IM,F (SBE3 Chokes: flush C,IM,F and extended IC,M) Type of Sights: Red-bar front sight Length of Pull: 14¼" Drop at Heel: 2¼" (SBE3 2¼") Drop at Comb: 1¼" †Receiver drilled and tapped for 93A Weaver base.

SPECIFICATIONS AND PRICES SUBJECT TO CHANGE WITHOUT NOTICE.

STANDARD FEATURES

CHOKE TUBES: C, IC, M, IM, F Crio® chokes for M2. IC, M, F chokes for SuperNova and Nova.
FINISHES: Mossy Oak® Bottomland™, Black synthetic.
DRILLED & TAPPED: M2 and SuperNova SteadyGrip™ receivers are drilled and tapped for scope mounting.

OPTIONAL FEATURES

BARREL: Fully rifled slug barrels.

Optional Long Pad
14¾" L.O.P.
ITEM # 81037

Optional Short Pad
13⅞" L.O.P.
ITEM # 81046



Optional Standard Pad
14⅜" L.O.P.
ITEM # 81038

Extra-High Comb
ITEM # 81045

Raised Comb
ITEM # 81044

Standard Comb
ITEM # 61102



Available for ComforTech® stocks only.

NOVA & SUPER NOVA PUMP TURKEY GUNS

ITEM NUMBER	BARREL LENGTH	STOCK	OVERALL LENGTH	AVERAGE WEIGHT	MSRP
NOVA PUMP 12-GAUGE 2¾", 3" AND 3½"					
20010	26"	Bottomland™	47.5"	7.9 lbs.	\$629
20003	26"	Black synthetic	47.5"	7.9 lbs.	\$499
NOVA PUMP 20-GAUGE 2¾" AND 3"					
20042	26"	Bottomland™	47.5"	6.6 lbs.	\$629
20043	24"	Bottomland™	45.5"	6.5 lbs.	\$629
NOVA PUMP COMPACT 20-GAUGE 2¾" AND 3"					
20036	24"	Black synthetic	44.2"	6.4 lbs.	\$499
SUPERNOVA PUMP 12-GAUGE 2¾", 3" AND 3½"					
20110	24"	Black synthetic	45.5"	7.8 lbs.	\$629

COMMON SPECIFICATIONS: Magazine Capacity: 4+1 Chokes: IC,M,F Type of Sights: Red-bar front sight Length of Pull: 14¼" (Compact 13") Drop at Heel: 2¼" (Compact 2") Drop at Comb: 1¼"



The SteadyGrip™ stock ensures a rock-solid grip in any weather and contributes to the outstanding accuracy of our turkey shotguns.

LUPO Bolt-Action Rifles
A Turn-Key Hot Rod

LUPO



LUPO BOLT-ACTION RIFLE, PROGRESSIVE COMFORT*
AA-Grade satin walnut, BE.S.T. gloss finish on barrel
(See page 66)



LUPO BOLT-ACTION RIFLE, PROGRESSIVE COMFORT*
OPTIFADE™ Open Country, Matte BE.S.T. (See page 64)



LUPO HPR BOLT-ACTION RIFLE, PROGRESSIVE COMFORT* **NEW!**
Tan/Black Webbing, Matte BE.S.T. (See page 70)



The measure of a hunting rifle is not how good it can be, but how good it is straight out of the box. Benelli set a high bar when developing the LUPO bolt-action rifle platform, and we delivered, giving hunters a gun that guarantees 3-shot MOA accuracy right from the factory when shooting premium ammunition. Featuring a precision-manufactured Crio-treated free-float barrel, a sculpted bolt built for strength and positive locking, fast 60-degree throw, and a carefully engineered stock system designed for comfort, custom fit, and marksmanship enhancement, the LUPO series bolt-action rifles represent the pinnacle of factory centerfire rifle performance.



SUB-M.O.A.

All Benelli LUPO field rifles include a 3-shot MOA guarantee with premium ammo.

All LUPO HPR rifles include a 5-shot .75" MOA guarantee with premium ammo.

“ The BE.S.T. Lupo is Benelli’s bid to reinvent the hunting rifle, and there’s no doubt the Italian brand is taking that task seriously. An accurate rifle that’s overflowing with forward-thinking rifle technology, the Lupo is going to continue to win fans as more hunters learn to love all that these guns offer. **Brad Fitzpatrick - American Hunter** ”

“ I think that Benelli’s sub-MOA accuracy statement is conservative. I contacted them and suggested that they offer a 3/4-MOA accuracy guarantee with the Lupo because I believe these rifles are entirely capable of that (or better) when paired with quality ammo. This is one of the most accurate out-of-the-box hunting rifles G&A has encountered. And it should be! The suggested retail price of the Lupo is \$1,699, which places it between the budget category and the high-end custom segment. **Eric Poole – Guns & Ammo** ”

LUPO Bolt-Action Rifle

Unmatched Innovation, Unrivaled Performance



LUPO BOLT-ACTION RIFLE, PROGRESSIVE COMFORT*
OPTIFADE™ Elevated II, Matte Labrador Gray BE.S.T.



LUPO BOLT-ACTION RIFLE, PROGRESSIVE COMFORT*
OPTIFADE™ Open Country, Matte BE.S.T.



LUPO

Benelli's Lupo bolt-action rifle has been field-tested on hunts across the globe and found to be a truly exceptional firearm. Not only has it delivered sub-MOA accuracy and decisive on-game performance, but hunters also rave about ergonomic and customization features that make it fit like it was made just for them. From the threaded muzzle to the recoil-mitigating Combtech® cheek pad, the Lupo is packed with Benelli features and technology shooters praise and declare unrivaled among hunting rifles. The Lupo is now available with Benelli's exclusive industry-leading BE.S.T. surface treatment and is available in three popular big-game calibers.



In addition to Benelli's industry-leading 10-year warranty, BE.S.T.-treated barrels and parts carry a warranty against rust and corrosion for 25 years from the date of purchase.

• **Accuracy:** The Lupo features a precision Crio-treated free-floating barrel attached to a hardened-steel barrel extension that is bedded to a steel block in the alloy receiver. The result is precision sub-MOA accuracy... shot-after-shot.

• **Advanced Ergonomics and Adjustability:** The shape of the Benelli Lupo has been optimized for control. The chassis-style configuration of a separate stock, receiver and forend allow the shooter to customize the Lupo to one of 36 drop and cast stock positions with the included shims. Further fit adjustments can be made by using the included length-of-pull spacers. Optional fit choices include extra-high and standard cheek pad styles and one optional-length butt pad.

• **Comfort:** The Benelli Lupo tames recoil with a patented built-in Progressive Comfort system and a Combtech cheek pad. The trigger is crisp and with an adjustable trigger-pull weight. Finger reach to the trigger is also adjustable with included spacers which can be placed between the receiver and the stock. The double-stack box magazine is incredibly easy to load inserted or out of the gun. The ambidextrous top safety is easy to access. AirTouch Grip surfaces allow for a safe and firm hold on the rifle.



LUPO BOLT-ACTION RIFLE

ITEM NUMBER	CALIBER	BARREL LENGTH	STOCK	OVERALL LENGTH	AVERAGE WEIGHT	MSRP
OPTIFADE OPEN COUNTRY, MATTE BE.S.T.						
11995	6.5 Creedmoor	24"	Open Country	46.225"	7.1 lbs.	\$1949
11996	.308 Winchester	22"	Open Country	44.225"	6.9 lbs.	\$1949
11997	.300 Win. Mag.	24"	Open Country	46.625"	7.1 lbs.	\$1949
OPTIFADE ELEVATED II, MATTE LABRADOR GRAY BE.S.T.						
11992	6.5 Creedmoor	24"	Elevated II	46.225"	7.1 lbs.	\$1949
11993	.308 Winchester	22"	Elevated II	44.225"	6.9 lbs.	\$1949
11994	.300 Win. Mag.	24"	Elevated II	46.625"	7.1 lbs.	\$1949

COMMON SPECIFICATIONS: Capacity: 5+1 (.300 Win. Mag. 4+1) Twist: .300 Win. Mag. and .308 Win. 1:11, RH; 6.5 Creedmoor 1:8, RH. Crio BBL: Free-floating, Threaded Length of Pull: Adjustable, 13.8" - 14.75" (14.2" - 15.2" with optional large Progressive Comfort pad). SPECIFICATIONS SUBJECT TO CHANGE WITHOUT NOTICE.

LUPO STANDARD FEATURES

- SCULPTED BOLT:** Three large locking lugs, 60-degree bolt throw.
- FINISHES:** Open Country/Matte BE.S.T., Elevated II/Matte Labrador gray BE.S.T.
- FREE-FLOATING CRIO BARREL**
- ADJUSTABLE TRIGGER:** 2.2 - 4.4 lbs.
- THREADED CRIO BARREL:** Accepts muzzle accessories, 5/8 x 24 threads.
- COMBTECH RAISED CHEEK PAD:** Mitigates felt facial recoil.
- PROGRESSIVE COMFORT:** Integrated recoil management.
- STOCK SPACERS:** Adjust length of pull from 13.8" - 14.75"
- TRIGGER REACH SPACERS:** Adjust trigger reach for custom fit.
- DETACHABLE BOX-TYPE MAGAZINE**
- INTEGRATED SWIVEL MOUNTS**
- 2-PIECE PICATINNY RAIL:** Quick and easy optics mounting.

OPTIONAL FEATURES

- PROGRESSIVE COMFORT - LARGE PAD:** Allows length of pull to be adjusted from 14.2" to 15.2".
- COMBTECH LOW AND EXTRA-HIGH CHEEK PAD:** Adjust cheek-weld height for a custom fit.

LUPO Bolt-Action Rifle
Field Agile, X-Ring Accurate



LUPO BOLT-ACTION RIFLE, PROGRESSIVE COMFORT™
AA-Grade satin walnut, BE.S.T. gloss finish on barrel

LUPO BOLT-ACTION RIFLE, PROGRESSIVE COMFORT™
Black synthetic.



LUPO



BE.S.T.
BENELLI SURFACE TREATMENT

LUPO STANDARD FEATURES

- SCULPTED BOLT:** Three large locking lugs, 60-degree bolt throw.
- FINISH:** AA-Grade satin walnut, BE.S.T. gloss finish on barrel.
- FREE-FLOATING CRIO BARREL**
- ADJUSTABLE TRIGGER:** 2.2 - 4.4 lbs.
- THREADED CRIO BARREL:** Accepts muzzle accessories, 5/8 x 24 threads.
- PROGRESSIVE COMFORT:** Integrated recoil management.
- STOCK SPACERS:** Adjust length of pull from 13.8" - 14.75"
- TRIGGER REACH SPACERS:** Adjust trigger reach for custom fit.
- DETACHABLE BOX-TYPE MAGAZINE**
- INTEGRATED SWIVEL MOUNTS**
- 2-PIECE PICATINNY RAIL:** Quick and easy optics mounting.

OPTIONAL FEATURES

- PROGRESSIVE COMFORT - LARGE PAD:** Allows length of pull to be adjusted from 14.2" to 15.2".

The wood-appointed Lupo has industry-leading gloss BE.S.T. treatment to prevent rust, corrosion and abrasions – so effective it's backed by a 25-year warranty! It includes a handsome AA-grade, checkered walnut stock and your choice of several popular big-game calibers.

LUPO BOLT-ACTION RIFLE

ITEM NUMBER	CALIBER	BARREL LENGTH	STOCK	OVERALL LENGTH	AVERAGE WEIGHT	MSRP
AA-GRADE SATIN WALNUT, GLOSS BE.S.T. FINISH						
11909	.300 Win. Mag.	24"	AA Satin Walnut	46.625"	7.1 lbs.	\$2299
11910	6.5 Creedmoor	24"	AA Satin Walnut	46.225"	7.1 lbs.	\$2299
11911	.308 Winchester	22"	AA Satin Walnut	44.225"	7.0 lbs.	\$2299
11912	.30-06 Spr.	22"	AA Satin Walnut	44.625"	7.0 lbs.	\$2299

COMMON SPECIFICATIONS: Capacity: 5+1 (.300 Win.Mag. 4+1) Twist: .30-06, .300 Win. Mag. and .308 Win. 1:11, RH; 6.5 Creedmoor 1:8, RH; Crio BBL: Free-floating, Threaded Length of Pull: Adjustable, 13.8" - 14.75" (14.2" - 15.2" with optional large Progressive Comfort pad). SPECIFICATIONS SUBJECT TO CHANGE WITHOUT NOTICE.



LUPO BOLT-ACTION RIFLE, PROGRESSIVE COMFORT™
ITEM # 11900 Black synthetic.

The Lupo is Benelli's first bolt-action rifle. Sub-MOA accuracy, advanced ergonomics, and shooting comfort have been carefully engineered into this chassis-style hunting rifle that allows for exclusive fit and customization out of the box. Lupo is Italian for wolf, and the Benelli Lupo is destined to dominate the land the way Benelli's Super Black Eagle dominates the skies.

The Lupo is packed with innovative features, including seven exclusive Benelli patents. The result is a superb hunting rifle offering a customized fit, exceptional handling, and proudly carries a three-shot, sub-MOA guarantee.

LUPO STANDARD FEATURES

- SCULPTED BOLT:** Three large locking lugs, 60-degree bolt throw.
- FINISHES:** Black synthetic stock, blued receiver and barrel.
- FREE-FLOATING CRIO BARREL**
- ADJUSTABLE TRIGGER:** 2.2 - 4.4 lbs.
- THREADED CRIO BARREL:** Accepts muzzle accessories, 5/8 x 24 threads.
- COMBTECH RAISED CHEEK PAD:** Mitigates felt facial recoil.
- PROGRESSIVE COMFORT:** Integrated recoil management.
- STOCK SPACERS:** Adjust length of pull from 13.8" - 14.75"
- TRIGGER REACH SPACERS:** Adjust trigger reach for custom fit.
- DETACHABLE BOX-TYPE MAGAZINE**
- INTEGRATED SWIVEL MOUNTS**
- 2-PIECE PICATINNY RAIL:** Quick and easy optics mounting.

OPTIONAL FEATURES

- PROGRESSIVE COMFORT - LARGE PAD:** Allows length of pull to be adjusted from 14.2" to 15.2".
- COMBTECH LOW AND EXTRA-HIGH CHEEK PAD:** Adjust cheek-weld height for a custom fit.

LUPO BOLT-ACTION RIFLE

ITEM NUMBER	CALIBER	BARREL LENGTH	STOCK	OVERALL LENGTH	AVERAGE WEIGHT	MSRP
BLACK SYNTHETIC, BLUED						
11900	.30-06 Spr.	22"	Black Synthetic	44.625"	7.0 lbs.	\$1699
11901	.300 Win. Mag.	24"	Black Synthetic	46.625"	7.1 lbs.	\$1699
11902	.270 Winchester	22"	Black Synthetic	44.625"	7.0 lbs.	\$1699
11903	6.5 Creedmoor	24"	Black Synthetic	46.225"	7.1 lbs.	\$1699
11904	.308 Winchester	22"	Black Synthetic	44.225"	6.9 lbs.	\$1699
11905	.243 Winchester	22"	Black Synthetic	44.225"	6.9 lbs.	\$1699
11906	7mm Rem. Mag.	24"	Black Synthetic	46.625"	7.1 lbs.	\$1699
11907	6.5 PRC	24"	Black Synthetic	46.625"	7.1 lbs.	\$1699
11908	6mm Creedmoor	24"	Black Synthetic	46.625"	7.1 lbs.	\$1699

COMMON SPECIFICATIONS: Capacity: 5+1 (.300 Win.Mag. 4+1) Twist: .30-06, .300 Win. Mag. and .308 Win. 1:11, RH; .270 Win. 1:10, RH; 6.5 Creedmoor 1:8, RH; .243 Win. 1:9, RH. 6.5 PRC 1:7.5, RH; 7mm Rem. Mag. 1:9.5, RH; Crio BBL: Free-floating, Threaded Length of Pull: Adjustable, 13.8" - 14.75" (14.2" - 15.2" with optional large Progressive Comfort pad). SPECIFICATIONS SUBJECT TO CHANGE WITHOUT NOTICE.

LUPO Bolt-Action Rifle
Benelli's Innovative Bolt-Action Rifle



Progressive Comfort

The Lupo tames recoil with a patented Progressive Comfort system built into the stock. Modified from Benelli's proven Progressive Comfort system used on shotguns, the system is engineered with sets of interlacing fingers that flex, absorbing much of the recoil before it reaches the shoulder. Decreased recoil, less muzzle flip and less anticipated recoil by the shooter result in a greater ability to stay accurately on target.



Stock Spacers for adjustable drop and cast

One of the truly unique features of the Lupo is the ability to adjust drop, cast and trigger reach with included shims. Shooters can achieve a customized fit out of the box without the need for expensive gunsmithing. Shims allow the stock to be set in one of 36 different positions, while the trigger reach spacers place the shooter's hand at an optimal distance from the trigger. Great fit equals better control... and increased accuracy.



Detachable box-type magazine

The detachable box magazine is a double-stack configuration with a partial divider that loads like a single stack. Cartridges can be easily loaded with the magazine removed, or smoothly top loaded with the magazine in place, holding five rounds without heavy spring pressure. The Lupo cutaway bolt works with the magazine, allowing the magazine to insert fully into the receiver without protruding from the bottom of the gun.



LUPO Barrel System

The Lupo was built for accuracy and the key is the Lupo barrel system. The barrel itself is free-floating and Crio-treated, resulting in a smoother and more uniform steel surface. The barrel is attached to hardened steel barrel extension bedded to a steel block in the chassis-style alloy receiver. The result of this unique design is precise sub-MOA accuracy.



LUPO HPR Bolt-Action Rifle
Dominate the Distance

NEW!



Steiner optic not included.



LUPO HPR
BE.S.T.



LUPO HPR BOLT-ACTION RIFLE, PROGRESSIVE COMFORT*
ITEM # 15701 Tan/Black Webbing, Matte BE.S.T.



In addition to Benelli's industry-leading 10-year warranty, BE.S.T.-treated barrels and parts carry a warranty against rust and corrosion for 25 years from the date of purchase.

Benelli's all-new LUPO HPR establishes an enviable benchmark for a factory-guaranteed sub-MOA (3/4-inch, 5-shot) long-range shooting and hunting bolt-action rifle. Chambered for the most popular long-range cartridges (6.5 PRC, 6.5 CRD, .338 LM, .300 PRC, .300 WM, and .308 WIN), the new Lupo HPR matches a revolutionary custom-fitment stock system with a heavy-contour, straight-fluted CRIO barrel to deliver a long-range rifle that incorporates the function of a chassis rifle with the handling grace and accuracy of a custom bolt-action. This hybrid platform answers the call of open country big-game and varmint hunters for a rifle that delivers the far-reaching accuracy of a competitive long-range custom rifle with the agility of a true hunting bolt-action.

LUPO HPR BOLT-ACTION RIFLE

ITEM NUMBER	CALIBER	BARREL LENGTH	STOCK	OVERALL LENGTH	AVERAGE WEIGHT	MSRP
SYNTHETIC, MATTE BE.S.T.						
15701	6.5 Creedmoor	24"	Tan/Black Webbing	46.25"	9.5 lbs.	\$2949
15604	.308 Win.	24"	Tan/Black Webbing	46.25"	9.4 lbs.	\$2949
15607	.300 Win. Mag.	26"	Tan/Black Webbing	48.25"	10.4 lbs.	\$2949
15609	.338 Lapua Mag.	26"	Tan/Black Webbing	48.25"	9.7 lbs.	\$2949
15608	.300 PRC	26"	Tan/Black Webbing	48.25"	9.8 lbs.	\$2949
15702	6.5 PRC	24"	Tan/Black Webbing	46.25"	9.6 lbs.	\$2949

COMMON SPECIFICATIONS: Capacity: 5+1 (.300 Win. Mag., .338 Lapua Mag., .300 PRC 4+1) Twist: .300 Win. Mag. and .308 Win. 1:11, RH; 6.5 Creedmoor 1:8, RH; .300 PRC. 1:8.5, RH; 6.5 PRC 1:7.5, RH; .338 Lapua Mag. 1:9.4, RH; Crio BBL: Free-floating, Threaded w/Muzzle Brake Length of Pull: Adjustable, 13.75" - 14.75". SPECIFICATIONS SUBJECT TO CHANGE WITHOUT NOTICE.

LUPO HPR STANDARD FEATURES

- SCULPTED BOLT:** Three large locking lugs, 60-degree bolt throw.
- FINISH:** Tan synthetic stock/black webbing, matte black BE.S.T. receiver, barrel and bolt.
- FREE-FLOATING CRIO BARREL**
- ADJUSTABLE TRIGGER:** 2.2 - 4.4 lbs.
- THREADED CRIO BARREL WITH BRAKE:** Accepts muzzle accessories, 5/8 x 24 threads.
- PUSH-BUTTON ADJUSTABLE COMB:** 8 height settings.
- PROGRESSIVE COMFORT:** Integrated recoil management.
- STOCK SPACERS:** Adjust length of pull from 13.75" - 14.75".
- DETACHABLE BOX-TYPE DOUBLE-STACK MAGAZINE**
- INTEGRATED QD AND M-LOK MOUNTS**
- ONE-PIECE 30 MOA PICATINNY RAIL:** Quick and easy optics mounting.

OPTIONAL FEATURES

- PROGRESSIVE COMFORT - LARGE PAD:** Allows length of pull to be adjusted from 14.2" to 15.2".



LUPO HPR Bolt-Action Rifle
Benelli's High Precision Rifle

LUPO HPR
BE.S.T.

BE.S.T.
BENELLI SURFACE TREATMENT

PROGRESSIVE COMFORT

QD Attachment Point

8-Position, Push-Button Adjustable Comb

Ambidextrous Safety

BE.S.T. Coated Bolt, Handle

Alloy Chassis

One-Piece Picatinny Rail (30 MOA)

QD Attachment Point

Improved Ergonomics

Fully Rounded AirTouch

Magpul M-Lok Attachment Points

Free-floating Fluted, Crio Barrel: Sub-MOA Precision

Matte BE.S.T. Coating

Threaded Crio Barrel, Muzzle Brake

Progressive Comfort System Provides Greater Recoil Reduction

Magpul M-Lok Attachment Point

Removable Bag Rider

Interchangeable Grip (Target or Hunting)

Adjustable Trigger

Detachable, Box-type Magazine (Double-stack)

Shims

PERFECT FIT

Shims Provide Drop and Cast Adjustment

PROGRESSIVE COMFORT

Target Grip

Hunting Grip

Stock Spacers

AIR TOUCH

M-LOK

SUB-M.O.A.

CRIO SYSTEM



One of the cornerstones of a precision rifle platform is proper fitment to the shooter's unique size and biomechanics. The LUPO HPR's all-new hybrid stock system provides the custom adjustability essential to bring out and enhance the shooter's marksmanship skills so they can make the long shots. Features include an 8-position comb height adjustment, interchangeable grip, stock spacers for LOP adjustment, and cast and drop shims to achieve optimal eye alignment behind the scope.

R1 Endurance Semi-Auto Rifle NEW!
Take the Bite Out of Recoil



 **PERFECT FIT**  **argo** Piston-Driven System  **CRIO SYSTEM**

BE.S.T.
BENELLI SURFACE TREATMENT

Benelli R1 Endurance rifles include a BE.S.T. treated piston rod for superior reliability.

 **COMFORTTECH 3**



R1 ENDURANCE RIFLE, COMFORTTECH® 3 – .308 WIN.
ITEM # 11761 Black synthetic



R1 ENDURANCE RIFLE – .308 WIN.
ITEM # 11781 A-Grade satin walnut

R1 ENDURANCE STANDARD FEATURES

FINISHES: Black synthetic, and A-Grade satin walnut.
BARRELS: CRIO®-treated barrels. **SHIM KIT:** For adjustment of drop and cast.
DRILLED & TAPPED: All R1 Endurance receivers are drilled and tapped for scope mounting and come equipped with a Picatinny rail.

OPTIONAL FEATURES

RECOIL PADS: Three options to customize length of pull to 13³/₈" , 14" or 14³/₈".
RAISED COMB PADS: Extra-high comb pads for scoped rifle (ComforTech® 3 only).
SIGHTS: Open adjustable rear blade and front fiber-optic.

R1 ENDURANCE RIFLE

ITEM NUMBER	BARREL LENGTH	STOCK	MAGAZINE CAPACITY	OVERALL LENGTH	AVERAGE WEIGHT	MSRP
R1 ENDURANCE RIFLE .30-06 SPRINGFIELD						
11782	22"	A-Grade walnut	5+1	44"	7.3 lbs.	\$1829
11762	22"	Black synthetic	5+1	44"	7.3 lbs.	\$1829
R1 ENDURANCE RIFLE .308 WINCHESTER						
11781	22"	A-Grade walnut	5+1	44"	7.3 lbs.	\$1829
11761	22"	Black synthetic	5+1	44"	7.3 lbs.	\$1829

COMMON SPECIFICATIONS: **Type of Sights:** Receiver is drilled and tapped for scope mount. Picatinny rail included with all models. Open sights available for purchase. **Twist:** 1:11, RH. **Length of Pull:** 13³/₈" **Drop at Heel:** 1¹/₄" **Drop at Comb:** 1¹/₄" **Comb:** Raised comb included.

SPECIFICATIONS AND PRICES SUBJECT TO CHANGE WITHOUT NOTICE.

Most sporting firearms today differ little in terms of technology from those developed a century ago. That's why the design team at Benelli set out to create something completely unique, and succeeded with the R1 Endurance semi-automatic hunting rifle – a trim, fast-handling firearm with style to spare.

The R1 Endurance's action is based on Benelli's innovative M4 military shotgun used by the United States Marine Corps. It incorporates the auto-regulating, gas-operated (A.R.G.O.) system adapted for use with

centerfire rifle cartridges paired with a three-lug rotary bolt. The gas cylinder is positioned to allow for a short operating rod, resulting in less felt recoil than other rifles.

The free-floating, cryogenically treated barrel is mated to a sturdy steel upper receiver to offer outstanding accuracy and a secure platform for mounting optics. The lower receiver is anodized aluminum to reduce weight.



Combtech® Comb Pad Inserts

Benelli engineers created a new cheek-comb pad called Combtech, which greatly reduces facial impact and vibrations. The insert not only cushions the shooter's cheek during recoil, but it is also very smooth so the cheek can slide along its surface at the shot for added comfort. Available in standard/low comb, or raised comb for target shooting and scoped guns. Fits SBE3, ETHOS Cordoba BE.S.T., ETHOS SuperSport and LUPO rifles with synthetic stocks.



Raised Comb
ITEM # 80260

Standard/Low Comb
ITEM # 80259

ComforTech® 3 Recoil Pads

Easily change the pull length of your SBE3, ETHOS Cordoba BE.S.T. and ETHOS SuperSport. Insert an optional recoil pad to alter the length of pull between 13⁷/₈" to 14⁷/₈". All pads have excellent recoil-reducing properties.



Optional Short
Recoil Pad
13⁷/₈" L.O.P.
ITEM #
80256

Standard Pad
14³/₈" L.O.P.
ITEM #
80257

Optional
Long Pad
14⁷/₈" L.O.P.
ITEM #
80258

R1 Rifle Sight Package



Optional open sights feature a fully adjustable rear blade and front sight with a special red fiber-optic insert.

ITEM # 81131



Shim Kits

You can customize models outfitted with the ComforTech® buttstock to your personal requirements using a shim kit that adjusts both drop and cast.

STOCK ADJUSTMENT KIT

12-GA. SBEII/M2/SuperSport/
Cordoba/Montefeltro/Legacy
ITEM # 60850

12-GA. VINCI/SUPER VINCI
ITEM #60811

12-GA. ETHOS
ITEM #60337

20-GA. Montefeltro/M2/
Legacy/SuperSport/Cordoba
ITEM # 83140

12-GA. Left-Hand Montefeltro
ITEM #60161

R1
ITEM #81173

Synthetic Pistol Grip



SUPERNOVA
Black synthetic – 12-ga.
(Non-adjustable drop)

STOCK ITEM # 60015

Chokes



STANDARD CHOKES 12-GAUGE, FLUSH

Fits: SuperNova, Nova, M4

ITEM # 80056P	F	ITEM # 80058P	IC
ITEM # 80061P	IM	ITEM # 80065P	C
ITEM # 80063P	M		

CRIO® CHOKES 12-GAUGE, FLUSH

Fits: SBell, M2, Montefeltro, Legacy, Vinci, SuperSport, Super Vinci, ETHOS, 828U

ITEM # 83000P	F	ITEM # 83003P	IC
ITEM # 83001P	IM	ITEM # 83004P	C
ITEM # 83002P	M		

CRIO® CHOKES 12-GAUGE EXTENDED, MATTE BLACK

Fits: SBell, M2, Montefeltro, Legacy, Vinci, SuperSport, Super Vinci, ETHOS, 828U

ITEM # 83015P	PASS	ITEM # 83017P	EXTRA-FULL TURKEY
ITEM # 83016P	DECOY		

CRIO® CHOKES 12-GAUGE EXTENDED, NICKEL-PLATED

Fits: SBell, M2, Montefeltro, Legacy, Vinci, SuperSport, Super Vinci, ETHOS, 828U

ITEM # 83028	F	ITEM # 83031	IC
ITEM # 83029	IM	ITEM # 83032	C
ITEM # 83030	M		

CRIO® CHOKES 20-GAUGE EXTENDED, NICKEL-PLATED

Fits: SuperSport, Cordoba, Legacy, Montefeltro, Ultra Light, M2

ITEM # 83168	F	ITEM # 83171	IC
ITEM # 83169	IM	ITEM # 83172	C
ITEM # 83170	M		

CRIO® CHOKES 12-GAUGE EXTENDED, PORTED, NICKEL-PLATED

Fits: SBell, M2, Montefeltro, Legacy, Vinci, SuperSport, Super Vinci, ETHOS, 828U

ITEM # 83040P	SKEET 1	ITEM # 83043P	MOD
ITEM # 83041P	IC	ITEM # 83044P	IM
ITEM # 83042P	SKEET 2		

STANDARD CHOKES 20-GAUGE, FLUSH (not shown)

Standard thread – Fits: Nova

ITEM # 80050P	F	ITEM # 80062P	IC
ITEM # 80051P	IM	ITEM # 80053P	C
ITEM # 80052P	M		

CRIO® CHOKES 20-GAUGE, FLUSH (not shown)

Fits: SuperSport, Cordoba, Legacy, Montefeltro, Ultra Light, M2

ITEM # 83054P	F	ITEM # 83051P	IC
ITEM # 83053P	IM	ITEM # 83050P	C
ITEM # 83052P	M		

CRIO® CHOKES 28-GAUGE, FLUSH (not shown)

Fits: Legacy 28-ga., ETHOS 28-ga., and Ultra Light 28-ga.

ITEM # 61332P	F	ITEM # 61335P	IC
ITEM # 61333P	IM	ITEM # 61336P	C
ITEM # 61334P	M		

CRIO® CHOKES 12-GAUGE EXTENDED, MATTE BLACK (not shown)

Fits: SBell, M2, Montefeltro, Legacy, Vinci, SuperSport, Super Vinci, ETHOS, 828U

ITEM # 83059	F	ITEM # 83056	IC
ITEM # 83058	IM	ITEM # 83055	C
ITEM # 83057	M		

CRIO® CHOKES 20-GAUGE EXTENDED, MATTE BLACK (not shown)

Fits: SuperSport, Cordoba, Legacy, Montefeltro, Ultra Light, M2

ITEM # 83157	F	ITEM # 83166	IC
ITEM # 83164	IM	ITEM # 83167	C
ITEM # 83165	M		

CRIO® CHOKES 20-GAUGE EXTENDED, PORTED, STAINLESS (not shown)

Fits: SuperSport, Cordoba, Legacy, Montefeltro, Ultra Light, M2

ITEM # 83045P	SKEET 1	ITEM # 83048P	MOD
ITEM # 83046P	IC	ITEM # 83049P	IM
ITEM # 83047P	SKEET 2		

STANDARD CHOKES 12-GAUGE EXTENDED, MATTE BLACK

Standard thread – Fits: Nova, SuperNova, M4

ITEM # 83020P	12-GA. PASS	ITEM # 80105P	12-GA. EXTRA-FULL TURKEY
ITEM # 83021P	12-GA. DECOY		

STANDARD CHOKES 20-GAUGE EXTENDED, MATTE BLACK (not shown)

Standard thread – Fits: Nova

ITEM # 83022P	20-GA. EXTRA-FULL TURKEY
---------------	---------------------------------

SPECIFICATIONS AND PRICES SUBJECT TO CHANGE WITHOUT NOTICE.

Range Series Bag & Gun Cases

Gear for a great day at the range



ULTRA RANGE BAG

Large enough for four boxes of shells, shooting glasses, chokes, a range towel and whatever else you might need for the day. Constructed of 1680D PVC-backed fabric, this range bag is built to last. EVA foam bottom, water-resistant zippers with custom pulls and removable internal dividers round-out the features on this premium bag. Measures 17" x 10" x 8".

ITEM # 94050 Black

GUN SOCK

Most gun cases hold in moisture, promoting rust. The Benelli gun sock actually lets the gun breathe and its material is impregnated with VCI to keep your gun lubricated and protected from rust.

ITEM # 90505 Black
ITEM # 90506 Red



A. RANGE SHOTGUN CASE

Attractive and durable case constructed of 600D PVC-backed fabric with custom-pull, water-resistant zippers. Snag- and tear-resistant 600D interior fabric lining. 53" case. ITEM # 94020 Black

B. RANGE RIFLE CASE

Attractive and durable case constructed of 600D PVC-backed fabric with heavy-duty zippers. Center pocket features an internal strap to keep binoculars secure during transport. Snag- and tear-resistant 600D interior fabric lining. 49" case. ITEM # 94025 Black

TACTICAL SHOTGUN CASE

Attractive and durable case constructed of 600D PVC-backed fabric with heavy-duty zippers. The back of the case features stowable backpack shoulder straps and the interior provides adjustable options for securing your firearm during transit. Snag- and tear-resistant 600D interior fabric lining. 42.5" case. ITEM # 94021 Black

Ducker & Lodge Series Gear
Simply Perfect for the Range or Field

A. DUCKER BACKPACK/BLIND BAG

An easy-carrying pack that's constructed of 600D PVC-backed fabric, making it very rugged and water resistant. This feature-rich bag includes: external shell holders, a hard-shell glasses pouch, custom zipper pulls, reinforced straps, and a padded, breathable back. The self-supporting EVA bottom design and easy-access zippered top make this pack ideal for any blind. Measures 17" x 7" x 12".

ITEM # 94031 Max-7™ ITEM # 94035 Bottomland™



B.

C. DUCKER PRO BLIND BAG

Securely transport everything for your hunt with the Ducker Pro Blind Bag. Constructed of 600D PVC-backed fabric, it features an EVA foam bottom, heavy-duty zippers and pulls, and strategically designed pouches and dividers to optimize organization. Measures 20" x 12" x 11".

ITEM # 94043 Max-7™
ITEM # 94046 Bottomland™



C.

D. LODGE DOVE BELT

Transporting and storage of birds and shells on the Dove Field is a literal snap with the Dove Belt system from Benelli's Lodge Collection. Constructed of waxed cotton, the shell pouches feature mechanical snap closures to ensure they stay either open or closed, while the game pouch uses magnetic snaps to keep game where you put it. A leather belt and water bottle holder round out this handsome offering.

ITEM # 94085 Olive Tan Canvas



D.

E. LODGE RANGE BAG

Makes transporting shells around a sporting course or to the field a breeze. This shooting bag from Benelli's Lodge Collection comfortably holds four boxes of shells and is equipped with both carry handles and a shoulder strap. Constructed of handsome, diamond-stitched waxed cotton with leather accents and a durable 210-lined interior, it also features a zippered front pocket with elastic loops for convenient storage of choke tubes. Measures 7" x 12" x 8" and fits four standard boxes of 25 shells (up to 12ga).

ITEM # 94080 Olive Tan Canvas



E.

F. LARGE LODGE SHELL POUCH

Easily transport multiple boxes of shells, loose or otherwise, at once in the Large Shell Pouch from Benelli's Lodge Collection. Constructed of handsome diamond-stitched waxed cotton with leather accents and a durable 600D interior, it also features unique shell loops for immediate access to five shells when quick follow-up shots are required. Measures 9.5" x 9.5" x 5".

ITEM # 94070 Olive Tan Canvas



F.



G.

G. SMALL LODGE SHELL POUCH

Easily carry a box of shells in the field or on the range with the Small Shell Pouch from Benelli's Lodge Collection. Constructed of handsome diamond-stitched waxed cotton with leather accents and a durable 600D interior, it also features unique shell loops for immediate access to two shells when quick follow-up shots are required. Measures 5.5" x 8" x 3" and fits one standard box of 25 shells (up to 12ga).

ITEM # 94075 Olive Tan Canvas



DUCKER PRO GUN CASE WITH POCKET

Modeled after traditional floater cases, the Ducker Pro is a sleek and durable take constructed of 600D PVD-backed fabric. A water-resistant primary zipper provides a generous opening for easy storage to and from the snag and tear free 600D interior, while an oversized front pocket allows for easy storage of chokes and a choke wrench. 53" case.

ITEM # 94091 Max-7™ ITEM # 94095 Bottomland™



DUCKER GUN CASE

600D PVC-backed fabric with custom-pull, water-resistant zippers to protect your prized Benelli. Snag- and tear-resistant 600D interior fabric lining. 53" case.

ITEM # 94001 Max-7™ ITEM # 94005 Bottomland™



LODGE GUN CASE

This diamond-stitched, waxed cotton Lodge Collection Gun Case offers excellent protection. Durable 600D interior fabric lining resists snags and tearing. A hidden pocket allows easy storage of choke tubes and a choke wrench.

ITEM # 94060 Olive Tan Canvas

SPECIFICATIONS AND PRICES SUBJECT TO CHANGE WITHOUT NOTICE.

Benelli Vests, Shooting Shirts & Pullovers



A. LODGE SHOOTING VEST

Constructed of wide mesh and breathable cotton, the Shooting Vest from Benelli's Lodge Collection is your ideal solution to those hot days on the range, course, or field. Diamond-stitched shoulders padded "just enough," oversized front pockets, and a rear pouch, round out this offering and provide the versatility demanded by serious shooters. Specify size when ordering: sizes S - XXL

ITEM # 94300 Olive Tan Canvas

Front

Back



Light Gray

Olive

B. LONG-SLEEVE SHOOTING SHIRT

Crafted specifically for warmer weather, this lightweight shooting shirt is perfectly suited for use throughout late-Spring to early-Fall conditions. Constructed from 4.7 oz., 92% Poly / 8% Spandex blend fabric with strategically placed 3 oz. mesh vents. Specify size when ordering: sizes S - XXL

ITEM # 95071 Olive
ITEM # 95072 Light Gray



Back

D. HEAVYWEIGHT QUARTER-ZIP HOODIE

Performance heavyweight 1/2-zip hoodie featuring microfleece interior, chest and kangaroo pockets, and modern thumbhole design in the sleeves for superior ability in the field. Constructed from 10.6 oz., 95% / 5% poly-spandex blend fabric. Specify size when ordering: sizes S - XXL

ITEM # 95066 Max-7™
ITEM # 95067 Dark Gray

Dark Gray



Dark Gray

Earth

C. HEAVYWEIGHT PULLOVER

Performance heavyweight 1/4-zip featuring microfleece interior and three "hidden" pockets for use in the field, constructed from 95% Poly/5% Spandex-blend fabric. Includes Benelli icon on back yoke. Specify size when ordering: sizes S - XXL

ITEM # 95053 Max-7™
ITEM # 95054 Bottomland™
ITEM # 95059 Dark Gray
ITEM # 95060 Earth



D.



Benelli Branded Hoodies



Charcoal Heather

Sand Dune

True Navy

A.

A. HEAVYWEIGHT HOODED LOGO SWEATSHIRT

Heavyweight modern style hoodie featuring microfleece moisture-wicking interior, constructed from 9.4 oz., 100% Polyester Fleece. Specify size when ordering: sizes S - XXL

- ITEM # 95057 Charcoal Heather
- ITEM # 95078 Military Green
- ITEM # 95079 Sand Dune
- ITEM # 95080 True Navy



Military Green



Cement

Steel Heather

B. VINTAGE LOGO HOODY

Comfortably cut, breathable midweight hoodie that's perfect for the Spring and Fall, constructed from 4.7 oz., 50% Cotton/50% Poly-blend fabric. Specify size when ordering: sizes S - XXL

- ITEM # 95076 Cement
- ITEM # 95077 Steel Heather



Blue Fog Heather

Lichen Green Heather

C.

Athletic Heather

C. HOODED PERFORMANCE PULLOVER

Lightweight Performance Hoodie featuring moisture-wicking, stain & odor resistance, and UPF 30+, constructed from 4.3 oz., 100% Performance Poly fabric. Specify size when ordering: sizes S - XXL

- ITEM # 95050 Athletic Heather
- ITEM # 95081 Blue Fog Heather
- ITEM # 95082 Lichen Green Heather

D. MIDWEIGHT PERFORMANCE HOODY

Performance midweight hoodie featuring a microfleece interior and modern thumbhole design for use as a mid-layer in the field. Constructed from 7.5 oz., 90% / 10% poly-spandex blend fabric. Specify size when ordering: sizes S - XXL

- ITEM # 95061 Bottomland™
- ITEM # 95062 Earth



Earth

D.

Benelli Branded T-Shirts

A.



Washed Black



Burnt Red

NEW!



Front

D.

NEW!



Front

E.

D. ELK CIRCLE T-SHIRT

A more modern fit, extra-soft Men's tee. Constructed from 4.3 oz., 40% Poly / 60% Cotton-blend fabric. Specify size when ordering: sizes S - XXXL

ITEM # 95016 Olive

E. DUCK CIRCLE T-SHIRT

A more modern fit, extra-soft Men's tee. Constructed from 4.3 oz., 40% Poly / 60% Cotton-blend fabric. Specify size when ordering: sizes S - XXXL

ITEM # 95015 Gray

B.



C.



A. DISTRESSED LOGO T-SHIRT

Pigment dyed for a worn-in look. Constructed from extra-soft 5.0 oz., 100% Cotton fabric. Specify size when ordering: sizes S - XXL

ITEM # 95000 Washed Black
ITEM # 95006 Burnt Red

B. DISTRESSED LOGO T-SHIRT

Slightly more trim fit, pre-shrunk garment, constructed from 4.5 oz., 90% Poly / 10% Cotton-blend fabric. Specify size when ordering: sizes S - XXL

ITEM # 95005 Premium Heather

C. DISTRESSED LOGO T-SHIRT

Slightly more trim fit, pre-shrunk garment, constructed from 4.5 oz., 35% Poly / 65% Cotton-blend fabric. Specify size when ordering: sizes S - XXL

ITEM # 95007 Heather Military Green



Front

F.



F. WATERFOWL FLAG T-SHIRT

A more modern fit, extra-soft Men's tee. Constructed from 4.3 oz., 40% Poly / 60% Cotton-blend fabric. Specify size when ordering: sizes S - XXL

ITEM # 95010 Oxford

G.



G. TACTICAL FLAG T-SHIRT

A more modern fit, extra-soft Men's tee. Constructed from 4.3 oz., 40% Poly / 60% Cotton-blend fabric. Specify size when ordering: sizes S - XXL

ITEM # 95009 Charcoal

Benelli Hoodies and Shirts

Garments Just for Her



A.

Desert Sage Heather

Blue Fog Heather

Medium Gray Heather

A. WOMEN'S VINTAGE LOGO HOODY
 Comfortably cut, breathable lightweight hoodie that's perfect for the Spring and Fall. This Women's cut hoodie is constructed from 4.7 oz., 100% Cotton fabric. Specify size when ordering: sizes S - XXL

- ITEM # 95083 Medium Gray Heather
- ITEM # 95084 Blue Fog Heather
- ITEM # 95085 Desert Sage Heather



B.

Medium Gray Heather

Blue Fog Heather

B. WOMEN'S LOGO HOODY
 Mineral washed, heavier-weight, French Terry fabric is the ultimate in softness and comfort. This women's cut hoodie is constructed from 7.5 oz., 48% Poly / 47% Cotton / 5% Rayon-blend fabric. Specify size when ordering: sizes S - XXL

- ITEM # 95086 Medium Gray Heather
- ITEM # 95087 Blue Fog Heather



Charcoal Heather



Desert Sage



Ocean Depths Heather



Pastel Lilac

C. WOMEN'S DISTRESSED LOGO T-SHIRT
 Stylish, extra-soft, and pre-shrunk garment, this Women's cut tee features a scooped neck and is constructed from 4.4 oz. 40% Poly / 60% Cotton-blend fabric. Specify size when ordering: sizes S - XXL

- ITEM # 95011 Charcoal Heather
- ITEM # 95012 Ocean Depths Heather
- ITEM # 95013 Desert Sage
- ITEM # 95014 Pastel Lilac

Benelli Beanies & Hats
We've Got You Covered!



#91032
Blaze



#91300
Max-7™



#91301
Bottomland™



#91311
Red



#91312
Black Multicam



#91218
Max-7™

#91212
Waxed Tan



#91213
Vintage Marsh



#91214
Vintage Timber



#91220
Faded Black



#91223
Faded Burgundy



#91221
Faded Black



#91209
Olive Drab Ripstop



#91310
Faded Navy



#91219
Charcoal
Ripstop



#91206
Blaze



#91203
Bottomland™



#91211
FDE Ripstop

2024 Authorized Commercial Dealer Price List

AUTHORIZED DEALER TOLL FREE NUMBER: 800-264-4962, FAX: 301-283-6988

BENELLI FIREARMS – EFFECTIVE JANUARY 1, 2024

Specifications and Prices Subject to Change Without Notice.
This price supercedes all previously issued price lists.

Item Number	Barrel Length	Description	Magazine Capacity	UPC Code	MSRP
BE.S.T. SUPER BLACK EAGLE 3†			12 GAUGE - 2¾", 3" and 3½"		
12101	26"	Black synthetic, ComforTech 3	3+1	650350121018	\$2,499
12102	28"	Black synthetic, ComforTech 3	3+1	650350121025	\$2,499
SUPER BLACK EAGLE 3† CERAKOTE			12 GAUGE - 2¾", 3" and 3½"		
11233	28"	OPTIFADE™ Waterfowl Marsh, Patriot Brown Cerakote, ComforTech 3	3+1	650350112337	\$2,399
11230	28"	OPTIFADE™ Waterfowl Timber, Tungsten Cerakote, ComforTech 3	3+1	650350112306	\$2,399
SUPER BLACK EAGLE 3†			12 GAUGE - 2¾", 3" and 3½"		
10321	26"	Black synthetic, ComforTech 3	3+1	650350103212	\$2,199
10316	28"	Black synthetic, ComforTech 3	3+1	650350103168	\$2,199
10380	28"	Satin walnut, Progressive Comfort,	3+1	650350103809	\$2,199
10310	26"	Realtree Max-7™, ComforTech 3	3+1	650350103106	\$2,299
10311	28"	Realtree Max-7™, ComforTech 3	3+1	650350103113	\$2,299
10360	26"	GORE™ OPTIFADE™ Waterfowl Timber, ComforTech 3	3+1	650350103601	\$2,299
10361	28"	GORE™ OPTIFADE™ Waterfowl Timber, ComforTech 3	3+1	650350103618	\$2,299
10385	28"	GORE™ OPTIFADE™ Waterfowl Marsh, ComforTech 3	3+1	650350103854	\$2,299
10350	26"	Mossy Oak Bottomland™, ComforTech 3	3+1	650350103502	\$2,299
10351	28"	Mossy Oak Bottomland™, ComforTech 3	3+1	650350103519	\$2,299
SUPER BLACK EAGLE 3 SteadyGrip™†			12 GAUGE - 2¾", 3" and 3½"		
10352	24"	Mossy Oak Bottomland™, SteadyGrip™	3+1	650350103526	\$2,349
SUPER BLACK EAGLE 3 Left-Hand†			12 GAUGE - 2¾", 3" and 3½"		
10371	28"	Black synthetic, ComforTech 3, Left-hand	3+1	650350103717	\$2,199
10376	28"	Realtree Max-7™, ComforTech 3, Left-hand	3+1	650350103762	\$2,299
SUPER BLACK EAGLE 3 CERAKOTE			12 GAUGE - 2¾" and 3"		
11240	28"	OPTIFADE™ Waterfowl Marsh, Patriot Brown Cerakote, ComforTech 3	3+1	650350112405	\$2,149
11241	28"	OPTIFADE™ Waterfowl Timber, Tungsten Cerakote, ComforTech 3	3+1	650350112412	\$2,149
SUPER BLACK EAGLE 3			12 GAUGE - 2¾" and 3"		
10322	26"	Black synthetic, ComforTech 3	3+1	650350103229	\$1,949
10317	28"	Black synthetic, ComforTech 3	3+1	650350103175	\$1,949
10309	28"	Realtree Max-7™, ComforTech 3	3+1	650350103090	\$2,049
10362	28"	GORE™ OPTIFADE™ Waterfowl Timber, ComforTech 3	3+1	650350103625	\$2,049
10353	28"	Mossy Oak Bottomland™, ComforTech 3	3+1	650350103533	\$2,049
NEW SUPER BLACK EAGLE 3 Compact			12 GAUGE - 2¾" and 3"		
11320	26"	Black synthetic, ComforTech 3	3+1	650350113204	\$1,949
BE.S.T. SUPER BLACK EAGLE 3			20 GAUGE - 2¾" and 3"		
12103	26"	Black synthetic, ComforTech 3	3+1	650350121032	\$2,299
12104	28"	Black synthetic, ComforTech 3	3+1	650350121049	\$2,299

†Receiver is drilled and tapped for 93A Weaver base. Specifications and prices subject to change without notice.

Item Number	Barrel Length	Description	Magazine Capacity	UPC Code	MSRP
SUPER BLACK EAGLE 3 CERAKOTE			20 GAUGE - 2¾" and 3"		
11242	28"	OPTIFADE™ Waterfowl Marsh, Patriot Brown Cerakote, ComforTech 3	3+1	650350112429	\$2,149
11243	28"	OPTIFADE™ Waterfowl Timber, Tungsten Cerakote, ComforTech 3	3+1	650350112436	\$2,149
SUPER BLACK EAGLE 3			20 GAUGE - 2¾" and 3"		
10340	26"	Black synthetic, ComforTech 3	3+1	650350103403	\$1,949
10341	28"	Black synthetic, ComforTech 3	3+1	650350103410	\$1,949
10348	26"	Realtree Max-7™, ComforTech 3	3+1	650350103489	\$2,049
10349	28"	Realtree Max-7™, ComforTech 3	3+1	650350103496	\$2,049
10342	26"	GORE™ OPTIFADE™ Waterfowl Timber, ComforTech 3	3+1	650350103427	\$2,049
10343	28"	GORE™ OPTIFADE™ Waterfowl Timber, ComforTech 3	3+1	650350103434	\$2,049
10346	26"	Mossy Oak Bottomland™, ComforTech 3	3+1	650350103465	\$2,049
10347	28"	Mossy Oak Bottomland™, ComforTech 3	3+1	650350103472	\$2,049
NEW SUPER BLACK EAGLE 3 Compact			20 GAUGE - 2¾" and 3"		
11330	26"	Black synthetic, ComforTech 3	3+1	650350113303	\$1,949
BE.S.T. SUPER BLACK EAGLE 3			28 GAUGE - 2¾" and 3"		
12105	26"	Black synthetic, ComforTech 3	3+1	650350121056	\$2,299
12106	28"	Black synthetic, ComforTech 3	3+1	650350121063	\$2,299
SUPER BLACK EAGLE 3			28 GAUGE - 2¾" and 3"		
10330	26"	Black synthetic, ComforTech 3	3+1	650350103304	\$1,949
10331	28"	Black synthetic, ComforTech 3	3+1	650350103311	\$1,949
10332	26"	GORE™ OPTIFADE™ Waterfowl Timber, ComforTech 3	3+1	650350103328	\$2,049
10333	28"	GORE™ OPTIFADE™ Waterfowl Timber, ComforTech 3	3+1	650350103335	\$2,049
10338	26"	Realtree Max-7™, ComforTech 3	3+1	650350103380	\$2,049
10339	28"	Realtree Max-7™, ComforTech 3	3+1	650350103397	\$2,049
10336	26"	Mossy Oak Bottomland™, ComforTech 3	3+1	650350103366	\$2,049
10337	28"	Mossy Oak Bottomland™, ComforTech 3	3+1	650350103373	\$2,049
NEW SUPER BLACK EAGLE 3 Compact			28 GAUGE - 2¾" and 3"		
11340	26"	Black synthetic, ComforTech 3	3+1	650350113402	\$1,949
ETHOS			12 GAUGE - 2¾" and 3"		
10461	26"	AA-Grade satin walnut, Nickel, Engraved, Progressive Comfort	4+1	650350104615	\$2,299
10462	28"	AA-Grade satin walnut, Nickel, Engraved, Progressive Comfort	4+1	650350104622	\$2,299
ETHOS			20 GAUGE - 2¾" and 3"		
10471	26"	AA-Grade satin walnut, Nickel, Engraved, Progressive Comfort	4+1	650350104714	\$2,299
10472	28"	AA-Grade satin walnut, Nickel, Engraved, Progressive Comfort	4+1	650350104721	\$2,299
ETHOS			28 GAUGE - 2¾" and 3"		
10480	26"	AA-Grade satin walnut, Nickel, Engraved, Progressive Comfort	2+1	650350104806	\$2,299
ETHOS SPORT			12 GAUGE - 2¾" and 3"		
10495	30"	AA-Grade satin walnut, Nickel, Progressive Comfort, Ported Barrel	4+1	650350104950	\$2,349
ETHOS SPORT			20 GAUGE - 2¾" and 3"		
10455	28"	AA-Grade satin walnut, Nickel, Progressive Comfort, Ported Barrel	4+1	650350104554	\$2,349
ETHOS SUPERSPORT			12 GAUGE - 2¾" and 3"		
10631	28"	Carbon fiber finish, Nickel/gloss blue, ComforTech 3, Ported Barrel	4+1	650350106312	\$2,349
10632	30"	Carbon fiber finish, Nickel/gloss blue, ComforTech 3, Ported Barrel	4+1	650350106329	\$2,349
ETHOS SUPERSPORT			20 GAUGE - 2¾" and 3"		
10633	28"	Carbon fiber finish, Nickel/gloss blue, ComforTech 3, Ported Barrel	4+1	650350106336	\$2,349

PRICE LIST

Item Number	Barrel Length	Description	Magazine Capacity	UPC Code	MSRP
BE.S.T. ETHOS CORDOBA			12 GAUGE - 2¾" and 3"		
10641	28"	BE.S.T., Black synthetic, ComforTech 3, Ported Barrel	4+1	650350106411	\$2,549
BE.S.T. ETHOS CORDOBA			20 GAUGE - 2¾" and 3"		
10643	28"	BE.S.T., Black synthetic, ComforTech 3, Ported Barrel	4+1	650350106435	\$2,549
BE.S.T. ETHOS CORDOBA			28 GAUGE - 2¾" and 3"		
10644	28"	BE.S.T., Black synthetic, ComforTech 3, Ported Barrel	2+1	650350106442	\$2,549
828U OVER/UNDER			12 GAUGE - 2¾" and 3"		
10701	26"	AA-Grade satin walnut, Black, Progressive Comfort		650350107012	\$3,099
10702	28"	AA-Grade satin walnut, Black, Progressive Comfort		650350107029	\$3,099
10705	30"	AA-Grade satin walnut, Black, Progressive Comfort		650350107050	\$3,099
10703	26"	AA-Grade satin walnut, Nickel, Engraved, Progressive Comfort		650350107036	\$3,699
10704	28"	AA-Grade satin walnut, Nickel, Engraved, Progressive Comfort		650350107043	\$3,699
10706	30"	AA-Grade satin walnut, Nickel, Engraved, Progressive Comfort		650350107067	\$3,699
10707	26"	AA-Grade satin walnut, Nickel, Engraved, Progressive Comfort, Left-hand		650350107074	\$3,399
10708	28"	AA-Grade satin walnut, Nickel, Engraved, Progressive Comfort, Left-hand		650350107081	\$3,399
10709	26"	AA-Grade satin walnut, Nickel, Engraved, Progressive Comfort, Compact		650350107098	\$3,399
828U OVER/UNDER			20 GAUGE - 2¾" and 3"		
10740	26"	AA-Grade satin walnut, Nickel, Engraved, Progressive Comfort		650350107401	\$3,699
10741	28"	AA-Grade satin walnut, Nickel, Engraved, Progressive Comfort		650350107418	\$3,699
NEW 828U OVER/UNDER STEEL FIELD			12 GAUGE - 2¾" and 3"		
10750	26"	AA-Grade satin walnut, Brushed Gray Receiver, Gloss Blue Barrels, Prog. Conf.		650350107500	\$3,699
10751	28"	AA-Grade satin walnut, Brushed Gray Receiver, Gloss Blue Barrels, Prog. Conf.		650350107517	\$3,699
10752	30"	AA-Grade satin walnut, Brushed Gray Receiver, Gloss Blue Barrels, Prog. Conf.		650350107524	\$3,699
NEW 828U OVER/UNDER STEEL FIELD			20 GAUGE - 2¾" and 3"		
10755	26"	AA-Grade satin walnut, Brushed Gray Receiver, Gloss Blue Barrels, Prog. Conf.		650350107555	\$3,699
10756	28"	AA-Grade satin walnut, Brushed Gray Receiver, Gloss Blue Barrels, Prog. Conf.		650350107562	\$3,699
828U SPORT OVER/UNDER			12 GAUGE - 2¾" and 3"		
10730	30"	AA-Grade satin walnut, Blue, Progressive Balancing		650350107302	\$4,799
10731	32"	AA-Grade satin walnut, Blue, Progressive Balancing		650350107319	\$4,799
M2 FIELD			12 GAUGE - 2¾" and 3"		
11160	24"	Black synthetic	3+1	650350111606	\$1,499
11161	26"	Black synthetic	3+1	650350111613	\$1,499
11162	28"	Black synthetic	3+1	650350111620	\$1,499
11164	26"	Realtree Max-7™	3+1	650350111644	\$1,599
11165	28"	Realtree Max-7™	3+1	650350111651	\$1,599
11166	26"	GORE™ OPTIFADE™ Waterfowl Timber	3+1	650350111668	\$1,599
11167	28"	GORE™ OPTIFADE™ Waterfowl Timber	3+1	650350111675	\$1,599
11168	26"	Mossy Oak Bottomland™	3+1	650350111682	\$1,599
11169	28"	Mossy Oak Bottomland™	3+1	650350111699	\$1,599
M2 FIELD Compact			12 GAUGE - 2¾" and 3"		
11170	26"	Black synthetic	3+1	650350111705	\$1,499
M2 FIELD Left-Hand (Classic Styling)			12 GAUGE - 2¾" and 3"		
11071	28"	Black synthetic, ComforTech, Left-hand	3+1	650350110715	\$1,499

†Receiver is drilled and tapped for 93A Weaver base. Specifications and prices subject to change without notice.
This program supercedes all previously issued programs. Price in effect is price at time of shipment.

Item Number	Barrel Length	Description	Magazine Capacity	UPC Code	MSRP
M2 FIELD			20 GAUGE - 2¾" and 3"		
11184	24"	Black synthetic	3+1	650350111842	\$1,499
11173	26"	Black synthetic	3+1	650350111736	\$1,499
11174	28"	Black synthetic	3+1	650350111743	\$1,499
11177	26"	Realtree Max-7™	3+1	650350111774	\$1,599
11178	28"	Realtree Max-7™	3+1	650350111781	\$1,599
11179	26"	GORE™ OPTIFADE™ Waterfowl Timber	3+1	650350111798	\$1,599
11180	28"	GORE™ OPTIFADE™ Waterfowl Timber	3+1	650350111804	\$1,599
11175	26"	Mossy Oak Bottomland™	3+1	650350111750	\$1,599
11176	28"	Mossy Oak Bottomland™	3+1	650350111767	\$1,599
M2 FIELD Compact			20 GAUGE - 2¾" and 3"		
11172	24"	Black synthetic	3+1	650350111729	\$1,499
11182	24"	Realtree Max-7™	3+1	650350111828	\$1,599
M2 FIELD Left-Hand (Classic Styling)			20 GAUGE - 2¾" and 3"		
11195	26"	Black synthetic, ComforTech, Left-hand	3+1	650350111958	\$1,499
M2 TACTICAL			12 GAUGE - 2¾" and 3"		
11053+	18.5"	Black synthetic, Tactical stock, Ghost-ring sight	5+1	650350110531	\$1,599
11054+	18.5"	Black synthetic, Pistol grip, Tactical rifle sight	5+1	650350110548	\$1,599
11052	18.5"	Black synthetic, Pistol grip, Ghost-ring sight	5+1	650350110524	\$1,699
11029+	18.5"	Black synthetic, ComforTech, Ghost-ring sight	5+1	650350110296	\$1,699
M3 TACTICAL (DUAL ACTION SEMI-AUTO/PUMP ACTION)			12 GAUGE - 2¾" and 3"		
11606	19.75"	Black synthetic, Tactical stock, Ghost-ring sight	5+1	650350116069	\$1,949
M4 TACTICAL (INCLUDES PICATINNY RAIL)†			12 GAUGE - 2¾" and 3"		
11707	18.5"	Black synthetic, Pistol grip, Ghost-ring sight	5+1	650350117073	\$2,299
11703	18.5"	Black synthetic, Tactical Stock, Ghost-ring sight	5+1	650350117035	\$2,299
M4 H₂O TACTICAL (INCLUDES PICATINNY RAIL)†			12 GAUGE - 2¾" and 3"		
11794	18.5"	Black synthetic, H ₂ O Titanium Cerakote, Pistol grip, Ghost-ring sight	5+1	650350117943	\$2,399
11795	18.5"	Black synthetic, H ₂ O Titanium Cerakote, Tactical Stock, Ghost-ring sight	5+1	650350117950	\$2,399
M1014 TACTICAL (INCLUDES PICATINNY RAIL)†			12 GAUGE - 2¾" and 3"		
11701	18.5"	Black synthetic, Fixed-position skeletonized stock, Ghost-ring sight	5+1	650350117011	\$2,299
11701CA	18.5"	Black synthetic, Fixed-position skeletonized stock, Ghost-ring sight	5+1	650350960006	\$2,299
MONTEFELTRO			12 GAUGE - 2¾" and 3"		
10881	26"	Satin walnut	4+1	650350108811	\$1,599
10882	28"	Satin walnut	4+1	650350108828	\$1,599
MONTEFELTRO Compact			12 GAUGE - 2¾" and 3"		
10887	26"	Satin walnut	4+1	650350108873	\$1,599
MONTEFELTRO Left-Hand (Classic Styling)			12 GAUGE - 2¾" and 3"		
10863	26"	Satin walnut	4+1	650350108637	\$1,299
10864	28"	Satin walnut	4+1	650350108644	\$1,299
MONTEFELTRO			20 GAUGE - 2¾" and 3"		
10884	26"	Satin walnut	4+1	650350108842	\$1,599
10885	28"	Satin walnut	4+1	650350108859	\$1,599
MONTEFELTRO Compact			20 GAUGE - 2¾" and 3"		
10886	24"	Satin walnut	4+1	650350108866	\$1,599

PRICE LIST

Item Number	Barrel Length	Description	Magazine Capacity	UPC Code	MSRP
NEW MONTEFELTRO SPORTING					
10891	30"	Satin walnut	4+1	650350108910	\$1,649
NEW MONTEFELTRO SPORTING					
10896	28"	Satin walnut	4+1	650350108965	\$1,649
MONTEFELTRO SILVER					
10850	28"	AA-Grade satin walnut, Nickel/blue, Etched game scene	4+1	650350108507	\$1,949
MONTEFELTRO SILVER					
10855	26"	AA-Grade satin walnut, Nickel/blue, Etched game scene	4+1	650350108552	\$1,949
MONTEFELTRO SILVER FEATHERWEIGHT					
10818	26"	Satin walnut/WeatherCoat™, Nickel/blue, Etched game scene	2+1	650350108187	\$2,199
MONTEFELTRO SILVER FEATHERWEIGHT					
10819	24"	Satin walnut/WeatherCoat™, Nickel/blue, Etched game scene	2+1	650350108194	\$2,199
NEW MONTEFELTRO ULTRA LIGHT					
10911	26"	AA-Grade satin walnut/WeatherCoat™, Gloss blue	4+1	650350109115	\$1,949
NEW MONTEFELTRO ULTRA LIGHT					
10915	24"	AA-Grade satin walnut/WeatherCoat™, Gloss blue	4+1	650350109153	\$1,949
LUPU Bolt-Action Rifle					
11900	22"	Black synthetic, Progressive Comfort, .30-06 Sprfld.	5+1	650350119008	\$1,699
11901	24"	Black synthetic, Progressive Comfort, .300 Win. Mag.	4+1	650350119015	\$1,699
11902	22"	Black synthetic, Progressive Comfort, .270 Win.	5+1	650350119022	\$1,699
11903	24"	Black synthetic, Progressive Comfort, 6.5 Creedmoor	5+1	650350119039	\$1,699
11904	22"	Black synthetic, Progressive Comfort, .308 Win.	5+1	650350119046	\$1,699
11905	22"	Black synthetic, Progressive Comfort, .243 Win.	5+1	650350119053	\$1,699
11907	24"	Black synthetic, Progressive Comfort, 6.5 PRC	5+1	650350119077	\$1,699
11906	24"	Black synthetic, Progressive Comfort, 7mm Remington Magnum	5+1	650350119060	\$1,699
11908	24"	Black synthetic, Progressive Comfort, 6mm Creedmoor	5+1	650350119084	\$1,699
BE.S.T. LUPU Bolt-Action Rifle					
11992	24"	Labrador Gray BE.S.T., Elevated II, Progressive Comfort, 6.5 Creedmoor	5+1	650350119923	\$1,949
11993	22"	Labrador Gray BE.S.T., Elevated II, Progressive Comfort, .308 Win.	5+1	650350119930	\$1,949
11994	24"	Labrador Gray BE.S.T., Elevated II, Progressive Comfort, .300 Win. Mag.	4+1	650350119947	\$1,949
11995	24"	Matte BE.S.T., Open Country, Progressive Comfort, 6.5 Creedmoor	5+1	650350119954	\$1,949
11996	22"	Matte BE.S.T., Open Country, Progressive Comfort, .308 Win.	5+1	650350119961	\$1,949
11997	24"	Matte BE.S.T., Open Country, Progressive Comfort, .300 Win. Mag.	4+1	650350119978	\$1,949
11909	24"	Gloss BE.S.T., AA-Grade satin walnut, Progressive Comfort, .300 Win. Mag.	4+1	650350119091	\$2,299
11910	24"	Gloss BE.S.T., AA-Grade satin walnut, Progressive Comfort, 6.5 Creedmoor	5+1	650350119107	\$2,299
11911	22"	Gloss BE.S.T., AA-Grade satin walnut, Progressive Comfort, .308 Win.	5+1	650350119114	\$2,299
11912	22"	Gloss BE.S.T., AA-Grade satin walnut, Progressive Comfort, .30-06 Sprfld.	5+1	650350119121	\$2,299
NEW BE.S.T. LUPU HPR Bolt-Action Rifle					
15701	24"	Matte BE.S.T., Tan/Blk. Webbing, Progressive Comfort, 6.5 Creedmoor	5+1	650350157017	\$2,949
15604	24"	Matte BE.S.T., Tan/Blk. Webbing, Progressive Comfort, .308 Win.	5+1	650350156041	\$2,949
15607	26"	Matte BE.S.T., Tan/Blk. Webbing, Progressive Comfort, .300 Win. Mag.	4+1	650350156072	\$2,949
15609	26"	Matte BE.S.T., Tan/Blk. Webbing, Progressive Comfort, .338 Lapua Mag.	4+1	650350156096	\$2,949
15608	26"	Matte BE.S.T., Tan/Blk. Webbing, Progressive Comfort, .300 PRC	4+1	650350156089	\$2,949
15702	24"	Matte BE.S.T., Tan/Blk. Webbing, Progressive Comfort, 6.5 PRC	5+1	650350157024	\$2,949
NEW R1 ENDURANCE Semi-Automatic Rifle					
11761	22"	.308 Winchester, ComforTech 3, Black synthetic	5+1	650350117615	\$1,829
11762	22"	.30-06 Springfield, ComforTech 3, Black synthetic	5+1	650350117622	\$1,829
11781	22"	.308 Winchester, AA-Grade satin walnut	5+1	650350117813	\$1,829
11782	22"	.30-06 Springfield, AA-Grade satin walnut	5+1	650350117820	\$1,829

This program supercedes all previously issued programs. Price in effect is price at time of shipment.

Item Number	Barrel Length	Description		Magazine Capacity	UPC Code	MSRP
PERFORMANCE SHOP ETHOS – UPLAND				12 GAUGE - 2¾" and 3"		
11461	26"	AA-Grade satin walnut, Nickel, Engraved, Progressive Comfort		4+1	650350114614	\$3,299
PERFORMANCE SHOP ETHOS – UPLAND				20 GAUGE - 2¾" and 3"		
11471	26"	AA-Grade satin walnut, Nickel, Engraved, Progressive Comfort		4+1	650350114713	\$3,299
NEW PERFORMANCE SHOP ETHOS – SUPERSPORT Adv. Impact				12 GAUGE - 2¾" and 3"		
12616	30"	Carbon fiber finish, Nickel/gloss blue, ComforTech [®] 3, Ported Barrel		4+1	650350126167	\$3,399
NEW PERFORMANCE SHOP ETHOS – CORDOBA Adv. Impact				12 GAUGE - 2¾" and 3"		
12631	28"	Matte BE.S.T., Black synthetic, ComforTech [®] 3, Ported Barrel		4+1	650350126310	\$3,649
NEW PERFORMANCE SHOP ETHOS – SPORT Adv. Impact				12 GAUGE - 2¾" and 3"		
12601	30"	AA-Grade satin walnut, Brushed Nickel, Progressive Comfort		4+1	650350126013	\$3,399
PERFORMANCE SHOP 828U OVER/UNDER – UPLAND				12 GAUGE - 2¾" and 3"		
10700	24"	AA-Grade satin walnut, Anodized Bronze/blue, Progressive Comfort			650350107005	\$3,999
PERFORMANCE SHOP 828U OVER/UNDER – UPLAND				20 GAUGE - 2¾" and 3"		
10712	24"	AA-Grade satin walnut, Anodized Bronze/blue, Progressive Comfort			650350107128	\$3,999
PERFORMANCE SHOP SBE 3 – TURKEY†				12 GAUGE - 2¾", 3" and 3½"		
11352	24"	Bottomland™, Pistol Grip, Ported, Burris Fast-Fire II Red Dot		3+1	650350113525	\$3,399
PERFORMANCE SHOP M2 – TURKEY†				20 GAUGE - 2¾" and 3"		
11197	24"	Bottomland™, ComforTech [®] Ported, Burris Fast-Fire II Red Dot		3+1	650350111972	\$2,949
PERFORMANCE SHOP SBE 3 – WATERFOWL				12 GAUGE - 2¾", 3" and 3½"		
11355	28"	OPTIFADE™ Timber/Matte Labrador Gray BE.S.T.		3+1	650350113556	\$3,649
PERFORMANCE SHOP SBE 3 – WATERFOWL				20 GAUGE - 2¾" and 3"		
11356	28"	OPTIFADE™ Timber/Matte Labrador Gray BE.S.T.		3+1	650350113563	\$3,399
PERFORMANCE SHOP SBE 3 – WATERFOWL				28 GAUGE - 2¾" and 3"		
11357	28"	OPTIFADE™ Timber/Matte Labrador Gray BE.S.T.		3+1	650350113570	\$3,399
PERFORMANCE SHOP M2 3-GUN				12 GAUGE - 2¾" and 3"		
11022	24"	Black synthetic, ComforTech [®]		3+1	650350110227	\$2,599

Item Number	Barrel Length	Description	Magazine Capacity	UPC Code	MSRP
SUPERNOVA COMFORTECH[®]			12 GAUGE - 2¾", 3" and 3½"		
20110	24"	Black synthetic, ComforTech [®]	4+1	650350201109	\$629
20105	26"	Black synthetic, ComforTech [®]	4+1	650350201055	\$629
20100	28"	Black synthetic, ComforTech [®]	4+1	650350201000	\$629
20116	26"	Realtree [®] Max-7™, ComforTech [®]	4+1	650350201161	\$749
20117	28"	Realtree [®] Max-7™, ComforTech [®]	4+1	650350201178	\$749
SUPERNOVA TACTICAL†			12 GAUGE - 2¾", 3" and 3½"		
20145	18.5"	Black synthetic, ComforTech [®] Tactical rifle sight	4+1	650350201451	\$579
20155	18.5"	Black synthetic, ComforTech [®] Ghost-ring sight	4+1	650350201550	\$629
20160	18.5"	Black synthetic, Pistol grip, Ghost-ring sight	4+1	650350201604	\$629
NOVA PUMP			12 GAUGE - 2¾", 3" and 3½"		
20003	26"	Black synthetic	4+1	650350200034	\$499
20000	28"	Black synthetic	4+1	650350200003	\$499
20065	26"	Realtree [®] Max-7™	4+1	650350200652	\$629
20066	28"	Realtree [®] Max-7™	4+1	650350200669	\$629
20010	26"	Mossy Oak [®] Bottomland™	4+1	650350200102	\$629
20011	28"	Mossy Oak [®] Bottomland™	4+1	650350200119	\$629

Specifications and prices subject to change without notice. † Receiver is drilled and tapped for 93A Weaver base.

PRICE LIST

Item Number	Barrel Length	Description	Magazine Capacity	UPC Code	MSRP
NOVA H20 PUMP			12 GAUGE - 2¾", 3" and 3½"		
20090	18.5"	Black synthetic, Matte nickel, Tactical rifle sight	4+1	650350200904	\$689
NOVA PUMP TACTICAL			12 GAUGE - 2¾", 3" and 3½"		
20051	18.5"	Black synthetic, Ghost-ring sight	4+1	650350200515	\$499
20050	18.5"	Black synthetic, Tactical rifle sight	4+1	650350200508	\$479
NOVA PUMP			20 GAUGE - 2¾" and 3"		
20036	24"	Black synthetic, Compact stock	4+1	650350200362	\$499
20030	26"	Black synthetic	4+1	650350200300	\$499
20043	24"	Mossy Oak' Bottomland™	4+1	650350200430	\$629
20042	26"	Mossy Oak' Bottomland™	4+1	650350200423	\$629
CLASS III NFA FIREARMS			12 GAUGE - 2¾" and 3"		
21001**††	14"	Nova Entry 12/14 Ghost-ring sights	4+1	650350210019	\$549
11038*†	14"	M2 Entry 12/14 Pistol grip, Ghost-ring sights	5+1	650350110388	\$1,549
11723*†	14"	M4 Entry 12/14 Tactical stock, Ghost-ring sights	5+1	650350117233	\$1,999
11722*†	14"	M4 Entry 12/14 Pistol grip, Ghost-ring sights	5+1	650350117226	\$1,999

* Only available to Class III Licensed Benelli USA Dealers. † Receiver is drilled and tapped for 93A Weaver base.

†† Nova receiver is drilled and tapped for 423M Weaver base.

ACCESSORIES

Item Number	Description	Gauge	UPC Code	MSRP
PERFORMANCE SHOP ACCESSORIES				
60010	Performance Shop Oversized Bolt Handle		650350600100	\$100
60004	TR & WF Ext. Bolt Release		650350600049	\$145
60005	RR Turkey Choke (Ext. Crio)		650350600056	\$125
60006	RR T1 Choke (Ext. Crio)		650350600063	\$125
60007	RR T2 Choke (Ext. Crio)		650350600070	\$125
60008	RR T3 Choke (Ext. Crio)		650350600087	\$125
60023	WF Hi Viz Sight		650350600230	\$25
61370	PS SuperSport Ext. Bolt Release		650350613704	\$55
61372	PS 12-ga. SS Bolt Handle		650350613728	\$60
61373	PS 12-ga. Cordoba Bolt Handle		650350613735	\$60
61374	PS 20-ga. SS Bolt Handle		650350613742	\$60
61376	PS 12-ga. LM Choke		650350613766	\$55
61377	PS 12-ga. SK Choke		650350613773	\$55
61378	PS 20-ga. LM Choke		650350613780	\$55
61379	PS 20-ga. SK Choke		650350613797	\$55
61381	PS SuperSport Weighted Mag Cap		650350613810	\$75
STOCK ADJUSTMENT KITS				
60161	Stock Drop Assby. Kit 12-ga., Fits Left-hand Montefeltro	12-ga.	650350601619	\$35
60850	Stock Drop Assby. Kit 12-ga., Fits SBE II, M2, SuperSport, Cordoba, Monte. Silver	12-ga.	650350608502	\$30
83140	Stock Drop Assby. Kit 20-ga., Fits Montefeltro, M2, SuperSport, Cordoba, Monte. Silver	20-ga.	650350831405	\$30
60811	Stock Drop Assby. Kit 12-ga., Fits Vinci, Super Vinci	12-ga.	650350608113	\$40
81173	Stock Drop Assby. Kit Fits R1		650350811735	\$45
60337	Stock Drop Kit Fits ETHOS	12-ga.	650350603378	\$45
80261	Stock Drop Kit Fits SBE 3	12-ga.	650350802610	\$35

Item Number	Description	Gauge/ Caliber	UPC Code	MSRP
BOLT HANDLES				
60071	Bolt Handle, Chrome	20-ga.	650350600711	\$40
60072	Bolt Handle, Chrome	12-ga.	650350600728	\$40
60084	Bolt Handle, Black	12-ga.	650350600841	\$40
61065	Bolt Handle Tactical, Black	12-ga.	650350610659	\$25
70041	Bolt Handle M4	12-ga.	650350700411	\$40
60456	Bolt Handle, Chrome, ETHOS	12-ga.	650350604566	\$40
61246	Bolt Handle, Black, SBE 3	12-ga.	650350612462	\$45
ETHOS RECOIL PAD KIT – 12-GAUGE				
80192	ETHOS Recoil Pad & New Housing - LOP to 13 ³ / ₄ " (Requires buttstock to be cut)	12-ga.	650350801927	\$165
80193	ETHOS Recoil Pad - LOP to 15"	12-ga.	650350801934	\$115
828U / LUPO / ETHOS (20-GAUGE ONLY) RECOIL PAD				
61586	828U or LUPO or ETHOS 20-ga. Recoil Pad - LOP to 15"		650350615869	\$70
61587	828U or LUPO or ETHOS 20-ga. Standard Recoil Pad - LOP to 14 ³ / ₈ "		650350615876	\$135
SBE 3 RECOIL & COMB PAD				
80256	SBE 3 Recoil Pad - Short	12-ga.	650350802566	\$100
80257	SBE 3 Recoil Pad - Medium	12-ga.	650350802573	\$100
80258	SBE 3 Recoil Pad - Long	12-ga.	650350802580	\$100
80259	SBE 3 Comb Pad - Standard	12-ga.	650350802597	\$100
80260	SBE 3 Comb Pad - Raised	12-ga.	650350802603	\$100
LUPO COMB PAD				
80259	LUPO Comb Pad - Standard	12-ga.	650350802597	\$100
80260	LUPO Comb Pad - Raised	12-ga.	650350802603	\$100
NOVA RECOIL PAD				
61000	Nova Recoil Pad - LOP to 13 ³ / ₄ " (Fits 20-gauge only)	20-ga.	650350610000	\$25
61001	Nova Short Stock Recoil Pad - LOP to 12 ¹ / ₂ " (Fits 20-gauge only)	20-ga.	650350610017	\$25
R1 RIFLE RECOIL PAD (Classic Styling)				
81085	R1 Recoil Pad - LOP to 13 ³ / ₈ ", Wood (Does NOT fit wood R1 Endurance)		650350810851	\$60
81090	R1 Recoil Pad - LOP to 14", Wood (Does NOT fit wood R1 Endurance)		650350810905	\$60
81095	R1 Recoil Pad - LOP to 14 ³ / ₈ ", Wood (Does NOT fit wood R1 Endurance)		650350810950	\$60
COMFORTECH® GEL COMB				
80226	ComforTech Standard Gel Comb		650350802269	\$100
81044	ComforTech Raised Gel Comb		650350810448	\$100
81045	ComforTech Extra-High Raised Gel Comb (right-hand guns only)		650350810455	\$100
COMFORTECH® GEL RECOIL PAD				
83120	ComforTech Gel Recoil Pad, Left-Hand- LOP to 14 ³ / ₈ "		650350831207	\$100
83121	ComforTech Gel Recoil Pad, Left-Hand- LOP to 14 ³ / ₄ "		650350831214	\$100
81047	ComforTech Gel Recoil Pad, Left-Hand- LOP to 13 ⁷ / ₈ "		650350810479	\$100
81038	ComforTech Gel Recoil Pad, Right-Hand- LOP to 14 ³ / ₈ "		650350810387	\$100
81037	ComforTech Gel Recoil Pad, Right-Hand- LOP to 14 ³ / ₄ "		650350810370	\$100
81046	ComforTech Gel Recoil Pad, Right-Hand- LOP to 13 ⁷ / ₈ "		650350810462	\$100
ETHOS & 828U COMB PAD				
60487	ETHOS, 828U Raised Comb		650350604870	\$100
MISCELLANEOUS PARTS & ACCESSORIES				
61519	828U Trigger Assembly Removal Tool		650350615197	\$10

This program supercedes all previously issued programs. Price in effect is price at time of shipment. Specifications and prices subject to change without notice.

PRICE LIST

Item Number	Description		Gauge/ Caliber	UPC Code	MSRP
LUPO MAGAZINES					
80336	5-Shot Lupo Magazine Assembly		.30-06/.270	650350803365	\$69
80337	4-Shot Lupo Magazine Assembly		.300 Win. Mag.	650350803372	\$69
80332	5-Shot Lupo Magazine Assembly		6.5 Creed/.308 Win.	650350803327	\$69
R1 MAGAZINES					
81123	10-Shot R1 Magazine, Matte		.30-06 Springfield	650350811230	\$100
81110	4-Shot R1 Magazine, Matte		.30-06 Springfield	650350811100	\$85
81120	3-Shot R1 Magazine, Matte		.300 Win. Mag.	650350811209	\$85
81420	3-Shot R1 Magazine, Matte		.338 Win.	650350814200	\$85
MAGAZINE CAPS					
61229	Magazine Cap SBE 3	Black	12-ga.	650350612295	\$50
61230	Magazine Cap SBE 3	Realtree Max-5™	12-ga.	650350612301	\$65
60232	Magazine Cap M2	Realtree Max-5™	20-ga.	650350602326	\$60
60137	Magazine Cap with QD Stud, SBE II/M2	Realtree Max-5™	12-ga.	650350601374	\$45
60162	Magazine Cap with QD Stud, SBE II/M2	Realtree Max-5™	12-ga.	650350601626	\$60
60332	Magazine Cap ETHOS	Matte	12-ga.	650350603323	\$70
60358	Magazine Cap with QD Stud, ETHOS	Matte	12-ga.	650350603583	\$75
61070	Magazine Cap with QD Stud, SBE II/M2	Matte	12-ga.	650350610703	\$50
60783	Magazine Cap SuperNova/Nova	Matte	12-ga.	650350607833	\$35
60114	Magazine Cap with QD Stud, Legacy/Montefeltro, Old Style	Matte	12- and 20-ga.	650350601145	\$50
60115	Magazine Cap Legacy/Montefeltro, Old Style	Matte	12- and 20-ga.	650350601152	\$45
83177	Magazine Cap Montefeltro Silver	Silver	12- and 20-ga.	650350831771	\$60
70051	Magazine Cap M4	Matte	12-ga.	650350700510	\$35
MAGAZINE LIMITER PLUGS					
80000	3 Round Mag Plug-Fits SBE/M1/SBE II & M2 w/short mag. extension			650350800005	\$25
60785	3 Round Mag Plug-Fits Nova		12-ga.	650350607857	\$10
80092	3 Round Mag Plug-Fits Montefeltro/Sport/Legacy			650350800920	\$20
80094	Standard Magazine Plug-Fits SBE/M1/SBE II/M2/SBE 3			650350800944	\$25
80095	Standard Magazine Plug-Fits M1/M2		20-ga.	650350800951	\$25
61009	3 Round Mag Plug-Fits Nova 20-ga.			650350610093	\$10
SIGHTS / BASES / RAILS / RIBS					
60794	Tritium Insert for ghost ring sights, Fits M1			650350607949	\$125
60795	Tritium Insert for ghost ring sights, Fits M4			650350607956	\$145
60805	Tritium Insert for ghost ring sights, Fits M2/Nova/SuperNova			650350608052	\$145
81130	R1 Scope Base - Picatinny			650350811308	\$105
81131	R1 Open Sights (Front & Rear)			650350811315	\$235
60458	Front Bead Sight, Fits SBE II/M2/SBE 3			650350604580	\$20
60202	Front Bead Sight, Fits Nova			650350602029	\$20
60868	Mid Bead Sight, Fits SBE II/M2/Vinci/SuperVinci/SBE 3			650350608687	\$20
60869	Front Bead Sight, Vinci, SuperVinci			650350608694	\$20
60377	Red Front Fiber-Optic Sight, Fits ETHOS			650350603774	\$20
60378	Green Front Fiber-Optic Sight, Fits ETHOS			650350603781	\$20
60383	Yellow Front Fiber-Optic Sight, Fits ETHOS			650350603835	\$20
60411	Carbon Rib - High, Fits ETHOS 12-ga. with 26" Barrel			650350604115	\$160
60413	Carbon Rib - High, Fits ETHOS 12-ga. with 28" Barrel			650350604139	\$160
60422	Carbon Rib - Low, Fits ETHOS 12-ga. with 26" Barrel			650350604221	\$160
60425	Carbon Rib - Low, Fits ETHOS 12-ga. with 28" Barrel			650350604252	\$160
61564	Carbon Rib - Low, Fits 828U 12-ga. with 26" Barrel			650350615647	\$135
61565	Carbon Rib - Low, Fits 828U 12-ga. with 28" Barrel			650350615654	\$135

This program supercedes all previously issued programs. Price in effect is price at time of shipment.
Specifications and prices subject to change without notice.

Item Number	Barrel Length	Description	Finish	Gauge	UPC Code	MSRP
BARRELS						
81126	20"	R1 Barrel and Bolt Assembly	Blue	.30-06	650350811261	\$700
81127	22"	R1 Barrel and Bolt Assembly	Blue	.30-06	650350811278	\$700
81128	20"	R1 Barrel and Bolt Assembly	Blue	.300 Win	650350811285	\$700
81129	24"	R1 Barrel and Bolt Assembly	Blue	.300 Win	650350811292	\$700
80247	26"	Super Black Eagle 3	Matte	12-ga.	650350802474	\$575
80248	28"	Super Black Eagle 3	Matte	12-ga.	650350802481	\$575
80250	26"	Super Black Eagle 3	Realtree Max-5™	12-ga.	650350802504	\$635
80251	28"	Super Black Eagle 3	Realtree Max-5™	12-ga.	650350802511	\$635
80178	26"	ETHOS	Blue	12-ga.	650350801781	\$665
80179	28"	ETHOS	Blue	12-ga.	650350801798	\$665
80114	24"	M2 Field, Rifled Slug	Matte	12-ga.	650350801149	\$500
81079	24"	M2 Field, Rifled Slug	Matte	20-ga.	650350810790	\$535
81250	28"	M2 Field	Matte	12-ga.	650350812503	\$465
81255	26"	M2 Field	Matte	12-ga.	650350812558	\$465
81260	24"	M2 Field	Matte	12-ga.	650350812602	\$465
81265	21"	M2 Field	Matte	12-ga.	650350812657	\$465
80090	28"	M2 Field	Realtree Max-5™	12-ga.	650350800906	\$535
80096	26"	M2 Field	Realtree Max-5™	12-ga.	650350800968	\$535
81015	26"	M2 Field	Matte	20-ga.	650350810158	\$535
81016	24"	M2 Field	Matte	20-ga.	650350810165	\$535
80176	26"	M2 Field	Realtree Max-5™	20-ga.	650350801767	\$535
80177	28"	M2 Field	Realtree Max-5™	20-ga.	650350801774	\$535
61153	24"	M2 Field, Left-hand	Matte	12-ga.	650350611533	\$465
61152	26"	M2 Field, Left-hand	Matte	12-ga.	650350611526	\$465
61151	28"	M2 Field, Left-hand	Matte	12-ga.	650350611519	\$465
80093	28"	M2 Field, Left-hand	Realtree Max-5™	12-ga.	650350800937	\$535
61179	26"	Ultra Light	Blue	12-ga.	650350611793	\$600
80040	24"	Ultra Light	Blue	20-ga.	650350800401	\$600
80025	28"	Legacy/Montefeltro	Blue	12-ga.	650350800258	\$465
80024	26"	Legacy/Montefeltro	Blue	12-ga.	650350800241	\$465
80022	24"	Legacy/Montefeltro	Blue	12-ga.	650350800227	\$465
80034	26"	Legacy/Montefeltro	Blue	20-ga.	650350800340	\$465
80036	24"	Legacy/Montefeltro	Blue	20-ga.	650350800364	\$465
80044	28"	Montefeltro, Left-hand	Blue	12-ga.	650350800449	\$465
80043	26"	Montefeltro, Left-hand	Blue	12-ga.	650350800432	\$465
80028	18.5"	M2 Tactical, Rifle sights, Fixed Cylinder	Matte	12-ga.	650350800289	\$400
80008	18.5"	M2 Tactical, Ghost-ring sights, choke tubes	Matte	12-ga.	650350800081	\$465
80003	18.5"	M2 Tactical, Rifle sights with choke tubes	Matte	12-ga.	650350800036	\$435
60046	26"	M3 Field with choke tubes	Matte	12-ga.	650350600469	\$565
81245	18.5"	M4/M1014 with choke tube	Matte	12-ga.	650350812459	\$665
80071	28"	SuperNova/Nova	Realtree Max-5™	12-ga.	650350800715	\$400
80070	26"	SuperNova/Nova	Realtree Max-5™	12-ga.	650350800708	\$400
80210	28"	SuperNova/Nova	Matte	12-ga.	650350802108	\$335
80211	26"	SuperNova/Nova	Matte	12-ga.	650350802115	\$335
80212	24"	SuperNova/Nova	Matte	12-ga.	650350802122	\$335
81070	24"	SuperNova/Nova, Rifled slug	Matte	12-ga.	650350810707	\$400
81112	18.5"	SuperNova/Nova, Tactical, Ghost-ring sights	Matte	12-ga.	650350811124	\$320
81113	18.5"	SuperNova/Nova, Tactical, Rifle sights	Matte	12-ga.	650350811131	\$300
81111	18.5"	SuperNova/Nova, H20- 12 Gauge	Nickel	12-ga.	650350811117	\$400
81019	26"	Nova	Matte	20-ga.	650350810196	\$335
81020	24"	Nova	Matte	20-ga.	650350810202	\$335
81071	24"	Nova, Rifled slug	Matte	20-ga.	650350810714	\$400

PRICE LIST

Item Number	Description	Choke Selection	Gauge	UPC Code	MSRP
CHOKE WRENCHES					
60596	Choke Wrench		12-ga.	650350605969	\$45
60593	Choke Wrench		20-ga.	650350605938	\$45
60580	Nova Choke Wrench		12-ga.	650350605808	\$45
60585	Nova Choke Wrench		20-ga.	650350605853	\$45
61337	Choke Wrench		28-ga.	650350613377	\$45
CHOKE TUBES STANDARD THREAD					
80050P	Flush	Full	20-ga.	650350980196	\$20
80051P	Flush	Improved Modified	20-ga.	650350980202	\$20
80052P	Flush	Modified	20-ga.	650350980219	\$20
80053P	Flush	Cylinder	20-ga.	650350980226	\$20
80062P	Flush	Improved Cylinder	20-ga.	650350980394	\$20
80056P	Flush	Full	12-ga.	650350980233	\$20
80061P	Flush	Improved Modified	12-ga.	650350980240	\$20
80063P	Flush	Modified	12-ga.	650350980257	\$20
80065P	Flush	Cylinder	12-ga.	650350980264	\$20
80058P	Flush	Improved Cylinder	12-ga.	650350980271	\$20
83020P	Matte - Extended	Pass	12-ga.	650350982831	\$35
83021P	Matte - Extended	Decoy	12-ga.	650350982244	\$35
80105P	Matte - Extended	Extra Full Turkey	12-ga.	650350982459	\$35
80133P	Stainless - Extended	Full	12-ga.	650350980288	\$30
80134P	Stainless - Extended	Improved Modified	12-ga.	650350980295	\$30
80135P	Stainless - Extended	Modified	12-ga.	650350980301	\$30
80136P	Stainless - Extended	Improved Cylinder	12-ga.	650350980318	\$30
80137P	Stainless - Extended	Cylinder	12-ga.	650350980325	\$30
CHOKE TUBES - CRIO					
83000P	Crio - Flush	Full	12-ga.	650350982060	\$30
83001P	Crio - Flush	Improved Modified	12-ga.	650350981995	\$30
83002P	Crio - Flush	Modified	12-ga.	650350982077	\$30
83003P	Crio - Flush	Improved Cylinder	12-ga.	650350982084	\$30
83004P	Crio - Flush	Cylinder	12-ga.	650350982091	\$30
83050P	Crio - Flush, M2	Cylinder	20-ga.	650350971613	\$30
83051P	Crio - Flush, M2	Improved Cylinder	20-ga.	650350971620	\$30
83052P	Crio - Flush, M2	Modified	20-ga.	650350971637	\$30
83053P	Crio - Flush, M2	Improved Modified	20-ga.	650350971644	\$30
83054P	Crio - Flush, M2	Full	20-ga.	650350971651	\$30
61332P	Crio - Flush	Full	28-ga.	650350992694	\$30
61333P	Crio - Flush	Improved Modified	28-ga.	650350992700	\$30
61334P	Crio - Flush	Modified	28-ga.	650350992717	\$30
61335P	Crio - Flush	Improved Cylinder	28-ga.	650350992724	\$30
61336P	Crio - Flush	Cylinder	28-ga.	650350992731	\$30

Item Number	Description	Choke Selection	Gauge	UPC Code	MSRP
CHOKE TUBES - EXTENDED CRIO					
83015P	Matte, Crio - Extended	Pass Shooting	12-ga.	650350980806	\$35
83016P	Matte, Crio - Extended	Decoy Shooting	12-ga.	650350982220	\$35
83017P	Matte, Crio - Extended	Extra Full Turkey	12-ga.	650350980820	\$35
83032	Nickel-Plated, Crio - Extended	Cylinder	12-ga.	650350830323	\$120
83031	Nickel-Plated, Crio - Extended	Improved Cylinder	12-ga.	650350830316	\$120
83030	Nickel-Plated, Crio - Extended	Modified	12-ga.	650350830309	\$120
83029	Nickel-Plated, Crio - Extended	Improved Modified	12-ga.	650350830293	\$120
83028	Nickel-Plated, Crio - Extended	Full	12-ga.	650350830286	\$120
83045P	Crio - Extended, Ported Stainless	Skeet I	20-ga.	650350971569	\$45
83047P	Crio - Extended, Ported Stainless	Skeet II	20-ga.	650350971583	\$45
83040P	Crio - Extended, Ported Stainless	Skeet I	12-ga.	650350971514	\$45
83041P	Crio - Extended, Ported Stainless	Improved Cylinder	12-ga.	650350971521	\$45
83042P	Crio - Extended, Ported Stainless	Skeet II	12-ga.	650350971538	\$45
83043P	Crio - Extended, Ported Stainless	Modified	12-ga.	650350971545	\$45
83044P	Crio - Extended, Ported Stainless	Improved Modified	12-ga.	650350971552	\$45

Item Number	Description	Finish		UPC Code	MSRP
STOCKS AND FORENDS					
60015	Super Black Eagle II/M2/SuperNova	Synthetic	SteadyGrip™	650350600155	\$135
83161	Super Black Eagle II/M2/Non-ComforTech	Synthetic	stock	650350831610	\$165
83202	Super Black Eagle II/M2/Non-ComforTech	Realtree Max-5™	stock	650350832020	\$160
83100	Super Black Eagle II/M2	Synthetic	ComforTech	650350831009	\$335
60176	Super Black Eagle II/M2	Realtree Max-5™	ComforTech	650350601763	\$365
83103	Super Black Eagle II/M2	Synthetic	forend	650350831030	\$80
60184	Super Black Eagle II/M2	Realtree Max-5™	forend	650350601848	\$100
61150	Super Black Eagle II/M2 Slug	Synthetic	forend/modified	650350611502	\$70
60226	M2- 20-gauge	Realtree Max-5™	ComforTech	650350602265	\$465
60230	M2- 20-gauge	Realtree Max-5™	forend	650350602302	\$100
60516	M1/M3 Non-adjustable drop	Synthetic	stock	650350605167	\$85
80046	M1/M3 Pistol Grip, Black synthetic	Synthetic	stock	650350800463	\$110
81040	M4 Pistol Grip	Synthetic	stock	650350810400	\$135
81041	M4 Standard	Synthetic	stock	650350810417	\$135

This program supercedes all previously issued programs. Price in effect is price at time of shipment. Specifications and prices subject to change without notice.

PRICE LIST

Item Number	Description	Finish		UPC Code	MSRP
STOCKS AND FORENDS (continued)					
83175	Ultra Light- 20-gauge, WeatherCoat™	Walnut	stock	650350831757	\$265
83176	Ultra Light- 20-gauge, WeatherCoat™	Walnut	forend	650350831764	\$185
61158	Legacy- New Model- 12-gauge, AA-Grade	Walnut	stock	650350611588	\$435
83114	Legacy- New Model- 12-gauge, AA-Grade	Walnut	forend	650350831146	\$160
61159	Legacy- New Model- 20-gauge, AA-Grade	Walnut	stock	650350611595	\$435
61160	Legacy- New Model- 20-gauge, AA-Grade	Walnut	forend	650350611601	\$160
61143	Montefeltro- New Model- 12-gauge	Walnut	stock	650350611434	\$265
61157	Montefeltro- New Model- 20-gauge	Walnut	stock	650350611571	\$265
80069	Montefeltro- New Model- 12-gauge	Walnut	forend	650350800692	\$135
61145	Montefeltro- New Model- 20-gauge	Walnut	forend	650350611458	\$150
61163	Montefeltro- New Model- 20-gauge	Walnut	short stock	650350611632	\$190
81150	R1 Stock Assembly	AA-Grade Walnut	stock	650350811506	\$235
81151	R1 Stock Assembly	AA-Grade Walnut	forend	650350811513	\$185
83188	R1 Stock Assembly	Black synthetic	ComforTech®	650350831887	\$400
83187	R1 Stock Assembly	Black synthetic	forend	650350831870	\$105
61176	SuperNova- 12-gauge	Black synthetic	ComforTech® Stock	650350611762	\$190
60142	SuperNova- 12-gauge	Realtree® Max-5™	ComforTech® Stock	650350601428	\$235
60499	ETHOS- 12-gauge	AA-Grade Walnut	stock silver	650350604993	\$620
60486	ETHOS- 12-gauge	AA-Grade Walnut	short stock assy. silver	650350604863	\$655
60489	ETHOS- 12-gauge	AA-Grade Walnut	forend silver	650350604894	\$265
61235	SBE 3 ComforTech®3	Black synthetic	stock	650350612356	\$400
61236	SBE 3 ComforTech®3	Realtree® Max-5™	stock	650350612363	\$465
61237	SBE 3	Black synthetic	forend	650350612370	\$95
61238	SBE 3	Realtree® Max-5™	forend	650350612387	\$115

GEAR

Item Number	Description	Finish	Size	UPC Code	MSRP
BENELLI WATERFOWL FLAG T-SHIRT					
95010S	Benelli Waterfowl Flag T-Shirt	Oxford	S	6503509666534	\$30
95010M	Benelli Waterfowl Flag T-Shirt	Oxford	M	6503509666541	\$30
95010L	Benelli Waterfowl Flag T-Shirt	Oxford	L	6503509666558	\$30
95010XL	Benelli Waterfowl Flag T-Shirt	Oxford	XL	6503509666565	\$30
95010XXL	Benelli Waterfowl Flag T-Shirt	Oxford	XXL	6503509666572	\$30
BENELLI DISTRESSED TACTICAL FLAG T-SHIRT					
95009S	Benelli Tactical T-Shirt, Distressed Flag Design	Charcoal	S	6503509666480	\$30
95009M	Benelli Tactical T-Shirt, Distressed Flag Design	Charcoal	M	6503509666497	\$30
95009L	Benelli Tactical T-Shirt, Distressed Flag Design	Charcoal	L	6503509666503	\$30
95009XL	Benelli Tactical T-Shirt, Distressed Flag Design	Charcoal	XL	6503509666510	\$30
95009XXL	Benelli Tactical T-Shirt, Distressed Flag Design	Charcoal	XXL	6503509666527	\$30

Item Number	Description	Finish	Size	UPC Code	MSRP
BENELLI DISTRESSED LOGO T-SHIRT					
95000S	Benelli Distressed Logo T-Shirt	Washed Black	S	650350961904	\$30
95000M	Benelli Distressed Logo T-Shirt	Washed Black	M	650350961911	\$30
95000L	Benelli Distressed Logo T-Shirt	Washed Black	L	650350961928	\$30
95000XL	Benelli Distressed Logo T-Shirt	Washed Black	XL	650350961935	\$30
95000XXL	Benelli Distressed Logo T-Shirt	Washed Black	XXL	650350961942	\$30
95005S	Benelli Distressed Logo T-Shirt	Premium Heather	S	650350966282	\$30
95005M	Benelli Distressed Logo T-Shirt	Premium Heather	M	650350966299	\$30
95005L	Benelli Distressed Logo T-Shirt	Premium Heather	L	650350966305	\$30
95005XL	Benelli Distressed Logo T-Shirt	Premium Heather	XL	650350966312	\$30
95005XXL	Benelli Distressed Logo T-Shirt	Premium Heather	XXL	650350966329	\$30
95006S	Benelli Distressed Logo T-Shirt	Burnt Red	S	650350966336	\$30
95006M	Benelli Distressed Logo T-Shirt	Burnt Red	M	650350966343	\$30
95006L	Benelli Distressed Logo T-Shirt	Burnt Red	L	650350966350	\$30
95006XL	Benelli Distressed Logo T-Shirt	Burnt Red	XL	650350966367	\$30
95006XXL	Benelli Distressed Logo T-Shirt	Burnt Red	XXL	650350966374	\$30
95007S	Benelli Distressed Logo T-Shirt	Military Green Heather	S	650350966381	\$30
95007M	Benelli Distressed Logo T-Shirt	Military Green Heather	M	650350966398	\$30
95007L	Benelli Distressed Logo T-Shirt	Military Green Heather	L	650350966404	\$30
95007XL	Benelli Distressed Logo T-Shirt	Military Green Heather	XL	650350966411	\$30
95007XXL	Benelli Distressed Logo T-Shirt	Military Green Heather	XXL	650350966428	\$30
NEW BENELLI DUCK CIRCLE T-SHIRT					
95015S	Benelli Duck Circle T-Shirt	Gray	S	650350968255	\$30
95015M	Benelli Duck Circle T-Shirt	Gray	M	650350968262	\$30
95015L	Benelli Duck Circle T-Shirt	Gray	L	650350968279	\$30
95015XL	Benelli Duck Circle T-Shirt	Gray	XL	650350968286	\$30
95015XXL	Benelli Duck Circle T-Shirt	Gray	XXL	650350968293	\$30
95015XXXL	Benelli Duck Circle T-Shirt	Gray	XXXL	650350968408	\$30
NEW BENELLI ELK CIRCLE T-SHIRT					
95016S	Benelli Elk Circle T-Shirt	Olive	S	650350968309	\$30
95016M	Benelli Elk Circle T-Shirt	Olive	M	650350968316	\$30
95016L	Benelli Elk Circle T-Shirt	Olive	L	650350968323	\$30
95016XL	Benelli Elk Circle T-Shirt	Olive	XL	650350968330	\$30
95016XXL	Benelli Elk Circle T-Shirt	Olive	XXL	650350968347	\$30
95016XXXL	Benelli Elk Circle T-Shirt	Olive	XXXL	650350968415	\$30

This program supercedes all previously issued programs. Price in effect is price at time of shipment.
Specifications and prices subject to change without notice.

PRICE LIST

Item Number	Description	Finish	Size	UPC Code	MSRP
BENELLI WOMEN'S DISTRESSED LOGO T-SHIRT					
95011S	Benelli Women's Distressed Logo T-Shirt	Charcoal Heather	S	650350966930	\$30
95011M	Benelli Women's Distressed Logo T-Shirt	Charcoal Heather	M	650350966947	\$30
95011L	Benelli Women's Distressed Logo T-Shirt	Charcoal Heather	L	650350966954	\$30
95011XL	Benelli Women's Distressed Logo T-Shirt	Charcoal Heather	XL	650350966961	\$30
95011XXL	Benelli Women's Distressed Logo T-Shirt	Charcoal Heather	XXL	650350966978	\$30
95012S	Benelli Women's Distressed Logo T-Shirt	Ocean Depths Heather	S	650350966985	\$30
95012M	Benelli Women's Distressed Logo T-Shirt	Ocean Depths Heather	M	650350966992	\$30
95012L	Benelli Women's Distressed Logo T-Shirt	Ocean Depths Heather	L	650350967005	\$30
95012XL	Benelli Women's Distressed Logo T-Shirt	Ocean Depths Heather	XL	650350967012	\$30
95012XXL	Benelli Women's Distressed Logo T-Shirt	Ocean Depths Heather	XXL	650350967029	\$30
95013S	Benelli Women's Distressed Logo T-Shirt	Desert Sage	S	650350967036	\$30
95013M	Benelli Women's Distressed Logo T-Shirt	Desert Sage	M	650350967043	\$30
95013L	Benelli Women's Distressed Logo T-Shirt	Desert Sage	L	650350967050	\$30
95013XL	Benelli Women's Distressed Logo T-Shirt	Desert Sage	XL	650350967067	\$30
95013XXL	Benelli Women's Distressed Logo T-Shirt	Desert Sage	XXL	650350967074	\$30
95014S	Benelli Women's Distressed Logo T-Shirt	Pastel Lilac	S	650350967081	\$30
95014M	Benelli Women's Distressed Logo T-Shirt	Pastel Lilac	M	650350967098	\$30
95014L	Benelli Women's Distressed Logo T-Shirt	Pastel Lilac	L	650350967104	\$30
95014XL	Benelli Women's Distressed Logo T-Shirt	Pastel Lilac	XL	650350967111	\$30
95014XXL	Benelli Women's Distressed Logo T-Shirt	Pastel Lilac	XXL	650350967128	\$30
BENELLI WOMEN'S MEDIUMWEIGHT VINTAGE LOGO HOODIE					
95083S	Benelli Women's Vintage Logo Hoodie	Medium Gray Heather	S	650350967135	\$55
95083M	Benelli Women's Vintage Logo Hoodie	Medium Gray Heather	M	650350967142	\$55
95083L	Benelli Women's Vintage Logo Hoodie	Medium Gray Heather	L	650350967159	\$55
95083XL	Benelli Women's Vintage Logo Hoodie	Medium Gray Heather	XL	650350967166	\$55
95083XXL	Benelli Women's Vintage Logo Hoodie	Medium Gray Heather	XXL	650350967173	\$55
95084S	Benelli Women's Vintage Logo Hoodie	Blue Fog Heather	S	650350967180	\$55
95084M	Benelli Women's Vintage Logo Hoodie	Blue Fog Heather	M	650350967197	\$55
95084L	Benelli Women's Vintage Logo Hoodie	Blue Fog Heather	L	650350967203	\$55
95084XL	Benelli Women's Vintage Logo Hoodie	Blue Fog Heather	XL	650350967218	\$55
95084XXL	Benelli Women's Vintage Logo Hoodie	Blue Fog Heather	XXL	650350967227	\$55
95085S	Benelli Women's Vintage Logo Hoodie	Desert Sage Heather	S	650350967234	\$55
95085M	Benelli Women's Vintage Logo Hoodie	Desert Sage Heather	M	650350967241	\$55
95085L	Benelli Women's Vintage Logo Hoodie	Desert Sage Heather	L	650350967258	\$55
95085XL	Benelli Women's Vintage Logo Hoodie	Desert Sage Heather	XL	650350967265	\$55
95085XXL	Benelli Women's Vintage Logo Hoodie	Desert Sage Heather	XXL	650350967272	\$55
BENELLI WOMEN'S MEDIUMWEIGHT LOGO HOODIE					
95086S	Benelli Women's Logo Hoodie	Medium Gray Heather	S	650350967289	\$65
95086M	Benelli Women's Logo Hoodie	Medium Gray Heather	M	650350967296	\$65
95086L	Benelli Women's Logo Hoodie	Medium Gray Heather	L	650350967302	\$65
95086XL	Benelli Women's Logo Hoodie	Medium Gray Heather	XL	650350967319	\$65
95086XXL	Benelli Women's Logo Hoodie	Medium Gray Heather	XXL	650350967326	\$65
95087S	Benelli Women's Logo Hoodie	Blue Fog Heather	S	650350967333	\$65
95087M	Benelli Women's Logo Hoodie	Blue Fog Heather	M	650350967340	\$65
95087L	Benelli Women's Logo Hoodie	Blue Fog Heather	L	650350967357	\$65
95087XL	Benelli Women's Logo Hoodie	Blue Fog Heather	XL	650350967364	\$65
95087XXL	Benelli Women's Logo Hoodie	Blue Fog Heather	XXL	650350967371	\$65

This program supercedes all previously issued programs. Price in effect is price at time of shipment.

Item Number	Description	Finish	Size	UPC Code	MSRP
BENELLI QUARTER-ZIP HEAVYWEIGHT PULLOVER					
95053S	Benelli Quarter-Zip Heavyweight Pullover	Realtree® Max-7™	S	650350963069	\$80
95053M	Benelli Quarter-Zip Heavyweight Pullover	Realtree® Max-7™	M	650350963076	\$80
95053L	Benelli Quarter-Zip Heavyweight Pullover	Realtree® Max-7™	L	650350963083	\$80
95053XL	Benelli Quarter-Zip Heavyweight Pullover	Realtree® Max-7™	XL	650350963090	\$80
95053XXL	Benelli Quarter-Zip Heavyweight Pullover	Realtree® Max-7™	XXL	650350963106	\$80
95054S	Benelli Quarter-Zip Heavyweight Pullover	MossyOak Bottomland™	S	650350963113	\$80
95054M	Benelli Quarter-Zip Heavyweight Pullover	MossyOak Bottomland™	M	650350963120	\$80
95054L	Benelli Quarter-Zip Heavyweight Pullover	MossyOak Bottomland™	L	650350963137	\$80
95054XL	Benelli Quarter-Zip Heavyweight Pullover	MossyOak Bottomland™	XL	650350963144	\$80
95054XXL	Benelli Quarter-Zip Heavyweight Pullover	MossyOak Bottomland™	XXL	650350963151	\$80
95059S	Benelli Quarter-Zip Heavyweight Pullover	Dark Gray	S	650350965889	\$80
95059M	Benelli Quarter-Zip Heavyweight Pullover	Dark Gray	M	650350965896	\$80
95059L	Benelli Quarter-Zip Heavyweight Pullover	Dark Gray	L	650350965902	\$80
95059XL	Benelli Quarter-Zip Heavyweight Pullover	Dark Gray	XL	650350965919	\$80
95059XXL	Benelli Quarter-Zip Heavyweight Pullover	Dark Gray	XXL	650350965926	\$80
95060S	Benelli Quarter-Zip Heavyweight Pullover	Earth	S	650350965933	\$80
95060M	Benelli Quarter-Zip Heavyweight Pullover	Earth	M	650350965940	\$80
95060L	Benelli Quarter-Zip Heavyweight Pullover	Earth	L	650350965957	\$80
95060XL	Benelli Quarter-Zip Heavyweight Pullover	Earth	XL	650350965964	\$80
95060XXL	Benelli Quarter-Zip Heavyweight Pullover	Earth	XXL	650350965971	\$80
BENELLI HOODED PERFORMANCE PULLOVER					
95050S	Benelli Hooded Performance Pullover, UPF 30	Athletic Heather	S	650350962055	\$60
95050M	Benelli Hooded Performance Pullover, UPF 30	Athletic Heather	M	650350962062	\$60
95050L	Benelli Hooded Performance Pullover, UPF 30	Athletic Heather	L	650350962079	\$60
95050XL	Benelli Hooded Performance Pullover, UPF 30	Athletic Heather	XL	650350962086	\$60
95050XXL	Benelli Hooded Performance Pullover, UPF 30	Athletic Heather	XXL	650350962093	\$60
95081S	Benelli Hooded Performance Pullover, UPF 30	Blue Fog Heather	S	650350966831	\$60
95081M	Benelli Hooded Performance Pullover, UPF 30	Blue Fog Heather	M	650350966848	\$60
95081L	Benelli Hooded Performance Pullover, UPF 30	Blue Fog Heather	L	650350966855	\$60
95081XL	Benelli Hooded Performance Pullover, UPF 30	Blue Fog Heather	XL	650350966862	\$60
95081XXL	Benelli Hooded Performance Pullover, UPF 30	Blue Fog Heather	XXL	650350966879	\$60
95082S	Benelli Hooded Performance Pullover, UPF 30	Lichen Green Heather	S	650350966886	\$60
95082M	Benelli Hooded Performance Pullover, UPF 30	Lichen Green Heather	M	650350966893	\$60
95082L	Benelli Hooded Performance Pullover, UPF 30	Lichen Green Heather	L	650350966909	\$60
95082XL	Benelli Hooded Performance Pullover, UPF 30	Lichen Green Heather	XL	650350966916	\$60
95082XXL	Benelli Hooded Performance Pullover, UPF 30	Lichen Green Heather	XXL	650350966923	\$60
BENELLI MIDWEIGHT PERFORMANCE HOODIE					
95061S	Benelli Midweight Performance Hoodie	MossyOak Bottomland™	S	650350965988	\$70
95061M	Benelli Midweight Performance Hoodie	MossyOak Bottomland™	M	650350965995	\$70
95061L	Benelli Midweight Performance Hoodie	MossyOak Bottomland™	L	650350966008	\$70
95061XL	Benelli Midweight Performance Hoodie	MossyOak Bottomland™	XL	650350966015	\$70
95061XXL	Benelli Midweight Performance Hoodie	MossyOak Bottomland™	XXL	650350966022	\$70
95062S	Benelli Midweight Performance Hoodie	Earth	S	650350966039	\$70
95062M	Benelli Midweight Performance Hoodie	Earth	M	650350966046	\$70
95062L	Benelli Midweight Performance Hoodie	Earth	L	650350966053	\$70
95062XL	Benelli Midweight Performance Hoodie	Earth	XL	650350966060	\$70
95062XXL	Benelli Midweight Performance Hoodie	Earth	XXL	650350966077	\$70

Specifications and prices subject to change without notice.

PRICE LIST

Item Number	Description	Finish	Size	UPC Code	MSRP
BENELLI HEAVYWEIGHT LOGO HOODED SWEATSHIRT					
95057S	Benelli Logo Heavyweight Hoodie	Charcoal Heather	S	650350964196	\$75
95057M	Benelli Logo Heavyweight Hoodie	Charcoal Heather	M	650350964202	\$75
95057L	Benelli Logo Heavyweight Hoodie	Charcoal Heather	L	650350964219	\$75
95057XL	Benelli Logo Heavyweight Hoodie	Charcoal Heather	XL	650350964226	\$75
95057XXL	Benelli Logo Heavyweight Hoodie	Charcoal Heather	XXL	650350964530	\$75
95078S	Benelli Logo Heavyweight Hoodie	Military Green	S	650350966688	\$75
95078M	Benelli Logo Heavyweight Hoodie	Military Green	M	650350966695	\$75
95078L	Benelli Logo Heavyweight Hoodie	Military Green	L	650350966701	\$75
95078XL	Benelli Logo Heavyweight Hoodie	Military Green	XL	650350966718	\$75
95078XXL	Benelli Logo Heavyweight Hoodie	Military Green	XXL	650350966725	\$75
95079S	Benelli Logo Heavyweight Hoodie	Sand Dune	S	650350966732	\$75
95079M	Benelli Logo Heavyweight Hoodie	Sand Dune	M	650350966749	\$75
95079L	Benelli Logo Heavyweight Hoodie	Sand Dune	L	650350966756	\$75
95079XL	Benelli Logo Heavyweight Hoodie	Sand Dune	XL	650350966763	\$75
95079XXL	Benelli Logo Heavyweight Hoodie	Sand Dune	XXL	650350966770	\$75
95080S	Benelli Logo Heavyweight Hoodie	True Navy	S	650350966787	\$75
95080M	Benelli Logo Heavyweight Hoodie	True Navy	M	650350966794	\$75
95080L	Benelli Logo Heavyweight Hoodie	True Navy	L	650350966800	\$75
95080XL	Benelli Logo Heavyweight Hoodie	True Navy	XL	650350966817	\$75
95080XXL	Benelli Logo Heavyweight Hoodie	True Navy	XXL	650350966824	\$75
BENELLI MIDWEIGHT VINTAGE LOGO HOODIE					
95076S	Benelli Midweight Vintage Logo Hoodie	Cement	S	650350966589	\$55
95076M	Benelli Midweight Vintage Logo Hoodie	Cement	M	650350966596	\$55
95076L	Benelli Midweight Vintage Logo Hoodie	Cement	L	650350966602	\$55
95076XL	Benelli Midweight Vintage Logo Hoodie	Cement	XL	650350966619	\$55
95076XXL	Benelli Midweight Vintage Logo Hoodie	Cement	XXL	650350966626	\$55
95077S	Benelli Midweight Vintage Logo Hoodie	Steel Heather	S	650350966633	\$55
95077M	Benelli Midweight Vintage Logo Hoodie	Steel Heather	M	650350966640	\$55
95077L	Benelli Midweight Vintage Logo Hoodie	Steel Heather	L	650350966657	\$55
95077XL	Benelli Midweight Vintage Logo Hoodie	Steel Heather	XL	650350966664	\$55
95077XXL	Benelli Midweight Vintage Logo Hoodie	Steel Heather	XXL	650350966671	\$55
BENELLI QUARTER-ZIP HEAVYWEIGHT PERFORMANCE HOODIE					
95066S	Benelli Quarter-Zip Heavyweight Hoodie	Realtree Max-7™	S	650350966084	\$90
95066M	Benelli Quarter-Zip Heavyweight Hoodie	Realtree Max-7™	M	650350966091	\$90
95066L	Benelli Quarter-Zip Heavyweight Hoodie	Realtree Max-7™	L	650350966107	\$90
95066XL	Benelli Quarter-Zip Heavyweight Hoodie	Realtree Max-7™	XL	650350966114	\$90
95066XXL	Benelli Quarter-Zip Heavyweight Hoodie	Realtree Max-7™	XXL	650350966121	\$90
95067S	Benelli Quarter-Zip Heavyweight Hoodie	Dark Gray	S	650350966138	\$90
95067M	Benelli Quarter-Zip Heavyweight Hoodie	Dark Gray	M	650350966145	\$90
95067L	Benelli Quarter-Zip Heavyweight Hoodie	Dark Gray	L	650350966152	\$90
95067XL	Benelli Quarter-Zip Heavyweight Hoodie	Dark Gray	XL	650350966169	\$90
95067XXL	Benelli Quarter-Zip Heavyweight Hoodie	Dark Gray	XXL	650350966176	\$90

Item Number	Description	Finish	Size	UPC Code	MSRP
BENELLI LONG-SLEEVE SHOOTING SHIRT					
95071S	Benelli Long-Sleeve Shooting Shirt	Olive	S	650350966183	\$75
95071M	Benelli Long-Sleeve Shooting Shirt	Olive	M	650350966190	\$75
95071L	Benelli Long-Sleeve Shooting Shirt	Olive	L	650350966206	\$75
95071XL	Benelli Long-Sleeve Shooting Shirt	Olive	XL	650350966213	\$75
95071XXL	Benelli Long-Sleeve Shooting Shirt	Olive	XXL	650350966220	\$75
95072S	Benelli Long-Sleeve Shooting Shirt	Light Gray	S	650350966237	\$75
95072M	Benelli Long-Sleeve Shooting Shirt	Light Gray	M	650350966244	\$75
95072L	Benelli Long-Sleeve Shooting Shirt	Light Gray	L	650350966251	\$75
95072XL	Benelli Long-Sleeve Shooting Shirt	Light Gray	XL	650350966268	\$75
95072XXL	Benelli Long-Sleeve Shooting Shirt	Light Gray	XXL	650350966275	\$75
EMBROIDERED HATS & BEANIES					
91032	Benelli Logo Beanie	Blaze Orange		650350910322	\$25
91300	Benelli Logo Beanie	Realtree Max-7™		650350913002	\$25
91301	Benelli Logo Beanie	MossyOak Bottomland™		650350913019	\$25
91218	Benelli Logo Hat	Realtree Max-7™/Khaki Mesh		650350912180	\$25
91203	Benelli Logo Hat	MossyOak Bottomland™/Khaki Mesh		650350912036	\$25
91206	Benelli Logo Patch Hat	Blaze Orange		650350912067	\$25
91209	Benelli Logo Ripstop Hat	Olive Drab/Black Mesh		650350912098	\$25
91211	Benelli Logo Ripstop Hat	Flat Dark Earth/Black Mesh		650350912111	\$25
91219	Benelli Logo Ripstop Hat	Charcoal/Black Mesh		650350912197	\$25
NEW 91310	Benelli Logo Hat	Faded Navy/White Mesh		650350913101	\$25
NEW 91311	Benelli Logo Hat	Red/White Mesh		650350913118	\$25
NEW 91312	Benelli Logo Hat	Black Multicam/Black Mesh		650350913125	\$25
91212	Benelli Logo Arched Patch Hat	Waxed Tan/Brown Mesh		650350912128	\$25
91213	Benelli Logo Arched Patch Hat	Vintage Marsh/Brown Mesh		650350912135	\$25
91214	Benelli Logo Arched Patch Hat	Vintage Timber/Black Mesh		650350912142	\$25
91220	Benelli Logo Arched Patch Hat	Faded Black/White Mesh		650350912203	\$25
91221	Benelli Logo Arched Patch Hat	Faded Black/Gray Mesh		650350912210	\$25
91223	Benelli Logo Arched Patch Hat	Faded Burgundy/Gray Mesh		650350912234	\$25

This program supercedes all previously issued programs. Price in effect is price at time of shipment. Specifications and prices subject to change without notice.

PRICE LIST

Item Number	Description	Finish	Size	UPC Code	MSRP
-------------	-------------	--------	------	----------	------

SLINGS

90194	Benelli Paracord Sling	Dark Desert		650350901948	\$85
-------	------------------------	-------------	--	--------------	------

GUN CASES

	94001	Benelli Ducker Zippered Gun Case - 53"	Realtree Max-7™		650350940015	\$70
	94005	Benelli Ducker Zippered Gun Case - 53"	MossyOak Bottomland™		650350940053	\$70
	94091	Benelli Ducker Pro Gun Case - 53"	Realtree Max-7™		650350940916	\$85
	94095	Benelli Ducker Pro Gun Case - 53"	MossyOak Bottomland™		650350940954	\$85
	94020	Benelli Range Zippered Shotgun Case - 53"	Black		650350940206	\$60
NEW	94021	Benelli Tactical Shotgun Case - 42.5"	Black		650350940213	\$80
	94025	Benelli Range Zippered Rifle Case - 49"	Black		650350940251	\$80
	94060	Benelli Lodge Gun Case - 53"	Olive Tan Canvas		650350940602	\$125
	90505	Benelli Gun Sock with Benelli Logo	Black		650350905052	\$20
	90506	Benelli Gun Sock with Benelli Logo	Red		650350905069	\$20

GEAR BAGS/SHELL POUCHES

	94050	Benelli Ultra Range Bag	Black		650350940503	\$75
	94031	Benelli Ducker Backpack	Realtree Max-7™		650350940312	\$115
	94035	Benelli Ducker Backpack	MossyOak Bottomland™		650350940350	\$115
	94042	Benelli Ducker Blind Bag	Realtree Max-7™		650350940428	\$85
	94045	Benelli Ducker Blind Bag	MossyOak Bottomland™		650350940459	\$85
	94043	Benelli Ducker Pro Blind Bag	Realtree Max-7™		650350940435	\$130
	94046	Benelli Ducker Pro Blind Bag	MossyOak Bottomland™		650350940466	\$130
	94070	Benelli Large Lodge Shell Pouch	Olive Tan Canvas		650350940701	\$65
	94075	Benelli Small Lodge Shell Pouch	Olive Tan Canvas		650350940756	\$45
	94080	Benelli Lodge Range Bag	Olive Tan Canvas		650350940800	\$75
	94085	Benelli Lodge Dove Belt	Olive Tan Canvas		650350940855	\$80

NEW BENELLI LODGE SHOOTING VEST

	94300S	Benelli Lodge Shooting Vest	Olive Tan Canvas	S	650350968354	\$55
	94300M	Benelli Lodge Shooting Vest	Olive Tan Canvas	M	650350968361	\$55
	94300L	Benelli Lodge Shooting Vest	Olive Tan Canvas	L	650350968378	\$55
	94300XL	Benelli Lodge Shooting Vest	Olive Tan Canvas	XL	650350968385	\$55
	94300XXL	Benelli Lodge Shooting Vest	Olive Tan Canvas	XXL	650350968392	\$55

Specifications and prices subject to change without notice.

This program supercedes all previously issued programs. Price in effect is price at time of shipment.

For Sales, Customer Service, Accounting, and Marketing contact:

(301) 283-6981, fax (301) 283-6988

Visit us on the web at benelliusa.com or e-mail: info@benelliusa.com



**ONLY SHIP FIREARMS FOR WARRANTY REPAIR TO:
RETURN AUTHORIZATION REQUIRED PRIOR TO SHIPMENT**
Benelli USA Corp., 901 Eighth Street, Pocomoke, Maryland 21851

